

**ABV**

We design silence<sup>®</sup>



**ABV**

We design silence®

Since 1984

**FR**

Depuis 1984, ABV fabrique des solutions acoustiques de partition d'espaces publics et professionnels. Fidèle à sa tradition d'innovation et de service, l'entreprise continue aujourd'hui de mener les recherches écologiques et ergonomiques les plus pointues du secteur. Performantes, évolutives, personnalisables, écologiques et modulables, les solutions ABV anticipent les enjeux futurs et constituent le nouveau standard pour le confort des espaces de travail individuels et collectifs.

**DE**

Seit 1984 fertigt ABV Akustik-Lösungen für öffentliche und private Unternehmen. Getreu seiner Tradition von Innovation und Dienstleistung, setzt das Unternehmen heute sein Bestreben fort, die pointiertesten ökologischen und ergonomischen Forschungsergebnisse in die Fertigung seiner Produkte einfließen zu lassen. Leistungsstark, evolutiv, personalisierbar, ökologisch und modular: mit seinen Produkten stellt sich ABV den Herausforderungen der Zukunft und schafft einen neuen Komfortstandard für Einzel- oder Großraumbüros.

**NL**

Sinds 1984 ontwerpt en produceert ABV akoestische scheidingsystemen bestemd voor publieke en professionele ruimtes. Trouw aan haar traditie van innovatie en service, voert het bedrijf vandaag verder geavanceerd onderzoek uit naar ecologische en ergonomische oplossingen. Performant, innovatief, modulair en ecologisch anticipeert ABV de uitdagingen van de toekomst en vormt aldus de nieuwe standaard voor het comfort op de individuele en collectieve werkplek.

**EN**

Since 1984, ABV manufactures acoustic and partitioning screens intended for professional and public spaces. Many years being innovative and willing to provide the best service, makes that today the company keeps on working in ecological and ergonomic research. Outstanding, evolving and customized, ecological, modular, the ABV solutions respond to the future stakes and become the new comfort standard for any individual or public workspaces.



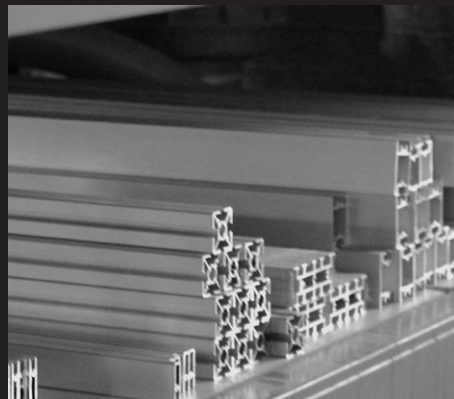
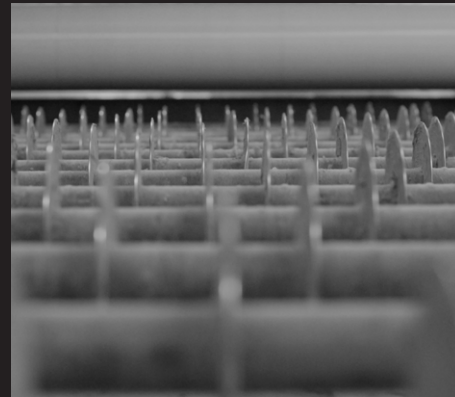
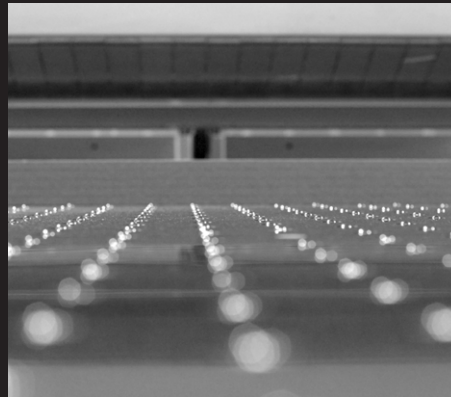

## FR

**We** Chez ABV, nous sommes un manufacturier. Nous fabriquons, depuis trente ans, des solutions sur mesure adaptées aux besoins des utilisateurs.

**Design** Le Design au centre de ses préoccupations d'ABV, tant dans la conception de solutions techniques, que dans le style de ses produits griffés par des designers de renom. ABV est une marque qui donne le ton en matière de Design techniquement et esthétiquement abouti.

**Silence** Depuis 1984, ABV a fait de l'acoustique et du confort un enjeu majeur. Grâce à une politique de Recherche & Développement continue, en partenariat avec l'Université de Liège, nous proposons les éléments de partition d'espace qui présentent les meilleures performances d'absorption acoustique du marché.

Plus qu'un quelconque slogan, les valeurs essentielles de l'entreprise se trouvent pérennisées par les nouveaux actionnaires actifs dans les opérations quotidiennes. C'est avec une vision à long terme que chez ABV: « *We Design Silence* »...

## DE

**We** Als Hersteller produziert ABV seit 30 Jahren maßgeschneiderte Lösungen je nach Wunsch der Endkunden.

**Design** Design wurde bei ABV immer Groß geschrieben, sei es bei der Gestaltung von originellen technischen Lösungen oder bei der Auswahl namhafter Designer. ABV ist eine der führenden Marken auf dem Gebiet des technischen und ästhetischen Designs.

**Silence** Bereits seit 1984 ist bei ABV die Akustik, als Garant für Komfort und Wohlbefinden, einer der wichtigsten Faktoren bei der Produktherstellung. Dank einer dynamischen und kontinuierlichen Forschungs- und Entwicklungspolitik bietet ABV, in Zusammenarbeit mit der Universität Lüttich, die leistungsfähigsten akustischen Raumteilungskomponenten in ganz Europa an.

Und das ist kein bloßer Verkaufslogan. Die Kernwerte des Unternehmens werden durch die neuen Aktionäre, die im Tagesgeschäft aktiv sind, getragen. Mit einer langfristigen und zukunftsweisenden Vision gilt für uns bei ABV: « *We Design Silence* »...

## NL

**We** Als fabrikant produceren WIJ bij ABV reeds dertig jaar oplossingen afgestemd op de behoeften van gebruikers.

**Design** ABV heeft DESIGN ten allen tijde centraal geplaatst, zowel bij het ontwerpen van technische oplossingen als voor wat betreft de stijl van haar producten, bedacht en ontworpen door gekende designers. ABV is een toonaangevend merk op het gebied van goed doordachte en afgewerkte techniek en stijl.

**Silence** Sinds het begin heeft ABV akoestiek als een belangrijk element van comfort beschouwd. In samenwerking met de Universiteit van Luik en dankzij een doorgedreven politiek van continue R&D brengen we oplossingen voor ruimteverdeling met de beste prestaties op vlak van geluidsabsorptie op de markt.

De kernwaarden van ABV worden mede door de nieuwe aandeelhouders, zelf dagdagelijks actief in het bedrijf, verankerd. In die zin is voor ABV "WE DESIGN SILENCE" dan ook eerder een lange-termijnvisie dan louter een verkoopsslogan.

## EN

**We** At ABV, We are manufacturers. Over 30 years building made to measure solutions to meet the end user's needs.

**Design** Design has always been the core of ABV's thoughts, from technical solution to the style of its products signed by renowned designers. ABV is a trendsetting brand in matters of well achieved technical and lifestyle design.

**Silence** Since 1984, ABV has always considered acoustics as being a major comfort issue. Thanks to its continuous Research & Development Policy, with the University of Liège. ABV offers the most performing acoustic space partition components throughout Europe.

Further than a baseline, the core values of the company are now guaranteed by the new shareholders who are involved in the day to day business. So, at ABV, it is for real and long that : « *We Design Silence* »...

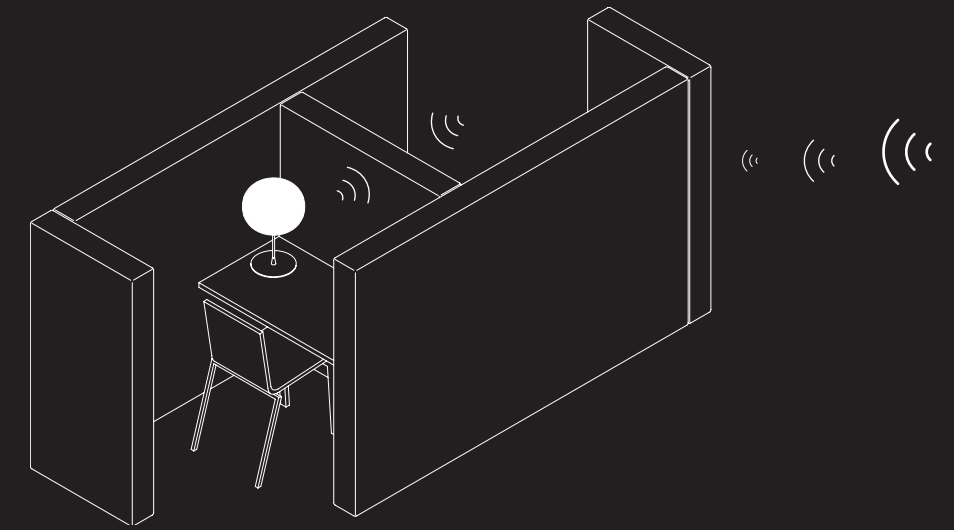
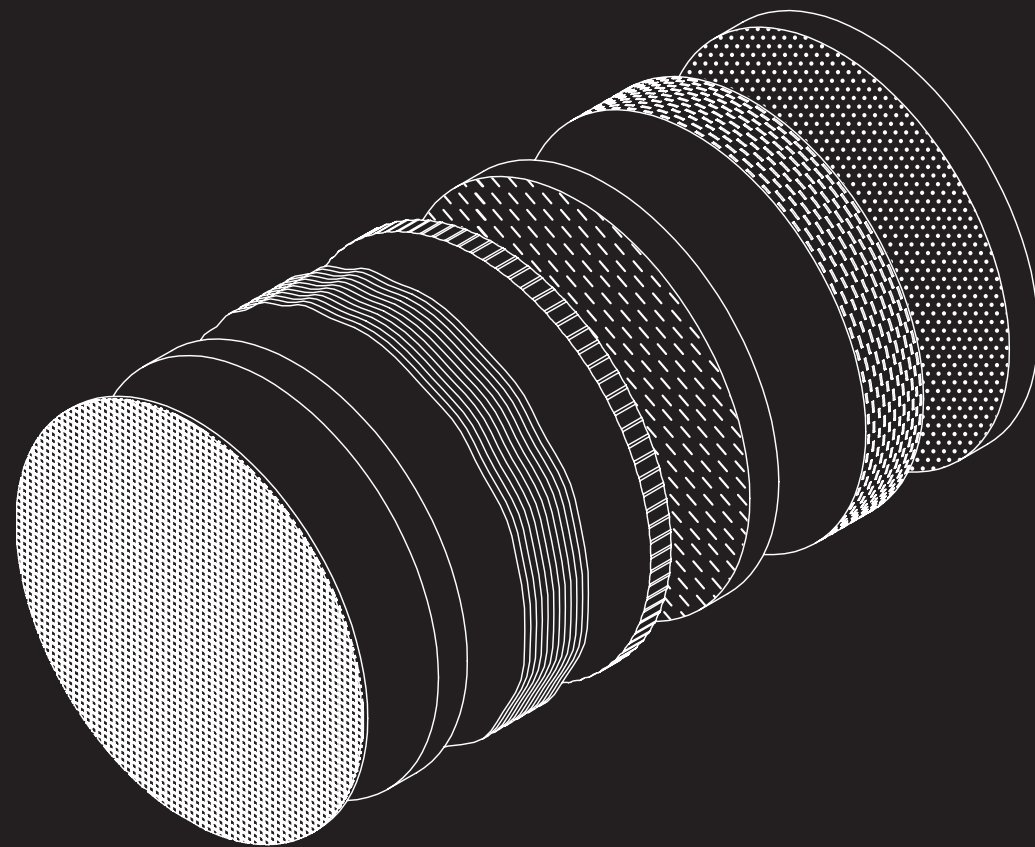

**FR**

Pionnière en matière d'acoustique, ABV a étudié et mis en œuvre des complexes de matériaux et des structures qui assurent les corrections les plus efficaces dans tous les types de situation. ABV propose aujourd'hui les meilleures performances d'absorption certifiées scientifiquement. Ce savoir-faire permet de créer une multitude de zones d'intimité dans les entreprises et endroits publics afin de répondre à l'antagonisme des besoins d'ouverture, de ressourcement et de confidentialité.

**DE**

Pionier in Sachen Akustik, erforscht und entwickelt ABV Materialien und Strukturen, um je nach Anforderung die bestmöglichen Lösungen zu gewährleisten. Wissenschaftliche Studien belegen, dass ABV-Produkte auf dem Markt die vergleichsweise höchsten akustischen Eigenschaften bieten. Durch dieses Know-how entstehen seit mehr als 30 Jahren in Unternehmen und öffentlichen Einrichtungen Zurückzugsbereiche, die ein hohes Maß an Konzentration, Selbstbesinnung und Privatsphäre bieten.

**NL**

Als pionier in akoestiek heeft ABV complexe materialen en structuren bestudeerd, ontwikkeld en geïmplementeerd om de meest efficiënte correcties in alle situaties te kunnen verzekeren. ABV biedt op heden de beste en wetenschappelijk gecertificeerde prestaties op vlak van geluidsabsorptieabsorptie. Deze know-how laat toe diverse privacy zones in bedrijven en openbare plaatsen te creëren, die beantwoorden aan de tegengestelde behoeften van grote toegankelijkheid enerzijds en herbronning en privacy anderzijds.

**EN**

A long-time pioneer in acoustics, ABV has studied, developed and implemented complex materials combinations that ensure the most effective noise correction for any spatial configuration. ABV now provides the best scientifically-certified absorption performance. This know-how is used by some of the world's best companies to create efficient privacy solutions in working and public environments, in order to resolve today's paradoxal needs of dynamic and open yet very private and calming spaces.





We design silence®

## Our designers



**Alain Berteau**  
Designer & Creative Director



**Julien Renault**  
Designer



**Quentin de Coster**  
Designer



**Hélène Boul**  
Designer



**Michael Kruijne**  
Designer



**Charles Kaisin**  
Designer

### FR

Depuis 1984, les produits ABV se distinguent par leur qualité de fabrication, leur avance technique, ainsi que par leurs performances de correction acoustique qui surpassent les standards du marché européen.

Au-delà d'une analyse méthodique des besoins de ses clients afin de proposer des solutions adaptées et efficaces, ABV édite les créations de designers reconnus dont l'approche essentielle et minimaliste magnifie et légitime le savoir-faire technique de la marque.

Alvar Aalto disait : « pour éviter l'obsolescence, un objet doit montrer une esthétique aussi durable que ses matériaux »

Résolument haut de gamme, les produits ABV se caractérisent par une approche simple, graphique et essentielle. Ils pérennisent la qualité des espaces grâce à l'intimité et la distinction qu'ils apportent.

### DE

Seit 1984 zeichnen sich ABV-Produkte durch hohe Fertigungsqualität, fortschrittliche Technologie, sowie durch hervorragende akustische Eigenschaften aus, die die Standards des europäischen Markts übertreffen.

Neben einer systematischen Analyse der Anforderungen seiner Kunden, um bedarfsgerechte Lösungen anzubieten, bringt ABV Kreationen anerkannter Designer auf den Markt, die durch ihre minimalistischen und klaren Ansätze das technische Know-how der Marke unterstreichen und hervorheben.

Alvar Aalto sagte: « Um Obsoleszenz zu vermeiden, muss ein Objekt eine Ästhetik vorweisen, die so haltbar ist, wie seine Materialien » .  
ABV-Produkte zeichnen sich durch einfache und klare Linien aus. So werden Orte des Wohlbefindens, der Ruhe und der Privatsphäre geschaffen.

### NL

Sinds 1984 onderscheiden de ABV producten zich door hun productiekwaliteit, hun geavanceerde technologie evenals door hun prestaties op gebied van akoestische correctie die de normen van de Europese markt overtreffen.

Naast de systematische analyse van de behoeften van haar klanten om passende en doeltreffende oplossingen te ontwikkelen, brengt ABV creaties van erkende ontwerpers op de markt wiens essentiële en minimalistische aanpak de legitimiteit en de technische knowhow van het merk uitbouwen.

Alvar Aalto zei: «Om veroudering te voorkomen, moet een object een esthetische waarde tonen even houdbaar is als de gebruikte materialen. »  
De hoogwaardige producten van ABV worden gekenmerkt door een eenvoudige, grafische en kritische benadering. Ze bestendigen de kwaliteit van ruimtes dankzij de privacy en het onderscheid die ze brengen.

### EN

Since 1984 ABV products have stood out from competitors. Their high-quality manufacturing, advanced technical features and of course, unparalleled acoustic performances exceed even the best european market standards.

ABV permanent innovation is fueled by a methodical monitoring of its client's needs, helping develop efficient and relevant new solutions. Working with some of the best designers, the brand never stops challenging itself and always pushes the boundaries of its technical know-how.

The great Alvaar Aalto once said that a product should fight obsolescence by offering a design aesthetic as durable and timeless as the physical solidity. Lasting, innovative, essential and emotional, ABV products are designed to enhance any room with a comfortably silent feeling.



Mood Tube









Fit Sofa





Mood Screen





Mood Screen





**Mood Slice**





We design silence®

Our products



P 28-29

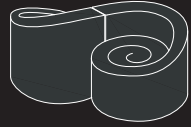

P 30-31



P 32-33

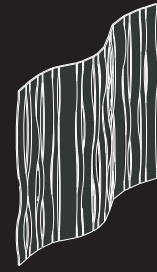

P 34-35

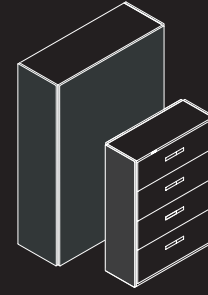

P 36-37

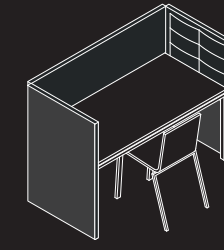

P 38-41

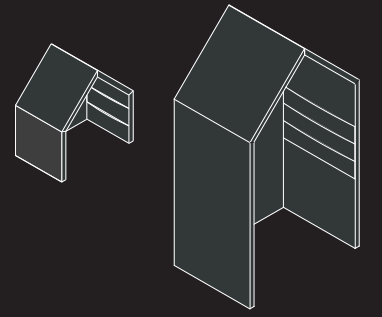

P 42-45

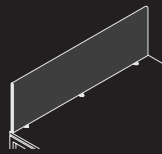

P 50

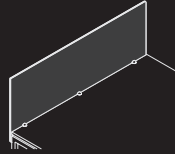

P 51



P 52-53

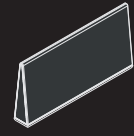

P 54-55

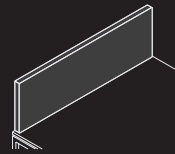

P 56-57



P 58-61



P 62-65

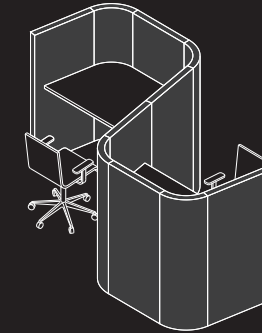

P 66-69

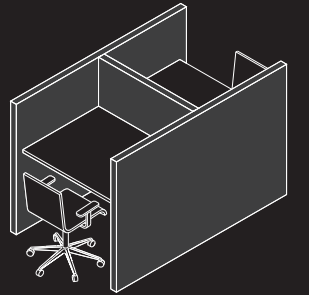

P 70-71

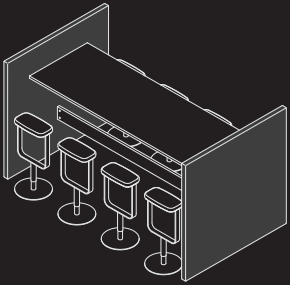

P 76-77

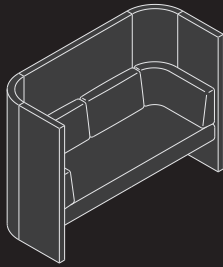

P 78-79

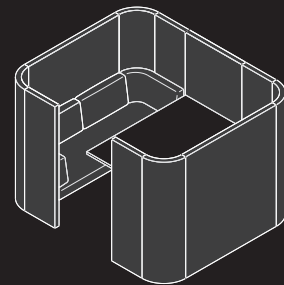

P 80-81

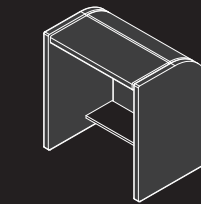
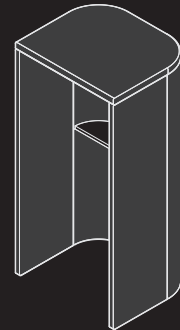

P 82-83

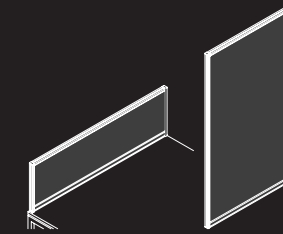

P 84-85

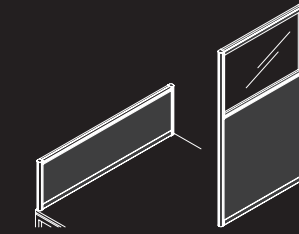

P 86-87

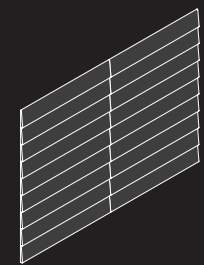

P 88-89

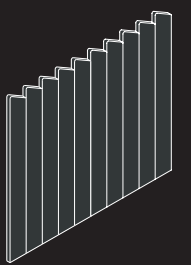

P 90-91

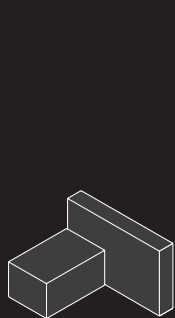
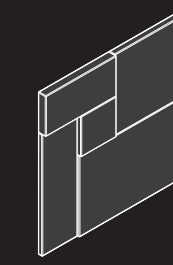
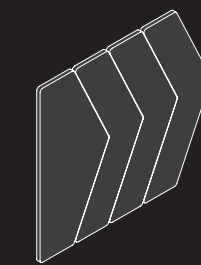
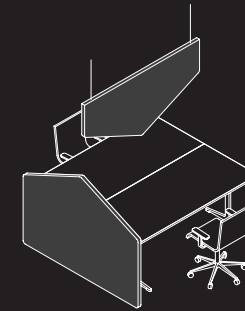
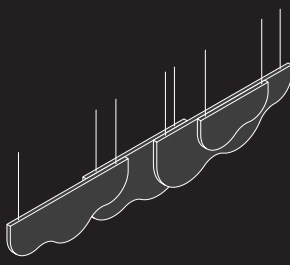

P 96-97

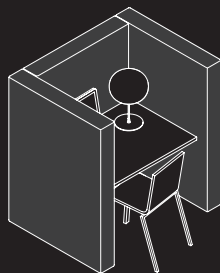

P 98-101

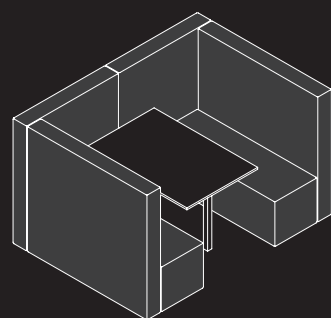

P 102-105

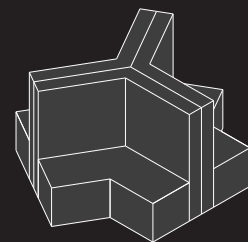

P 106-107

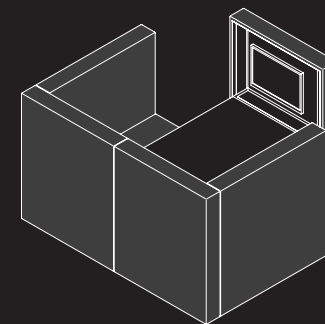

P 108-111

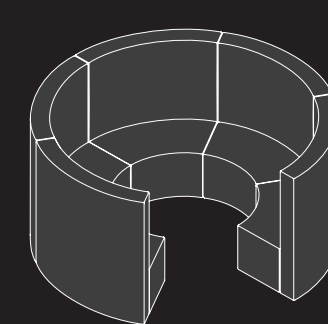

P 112-117

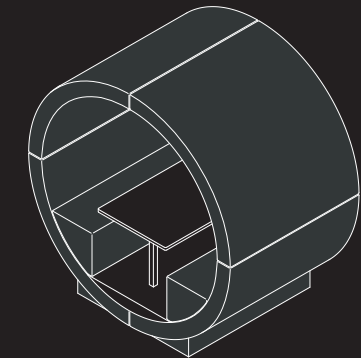

P 118-119

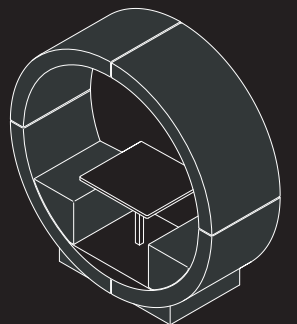



**ABV**

We design silence®

**Stand-Alone****FR**

Avec les collections «Stand-Alone» ABV définit une nouvelle catégorie de produits. Des solutions légères, abordables et écologiques, qui s'installent sans effort et améliorent instantanément les espaces et équipements existants. Utilisés pour régler des problèmes acoustiques, esthétiques ou fonctionnels, ils requalifient l'espace et deviendront rapidement des repères identifiables et familiers.

**DE**

Mit der Kollektion «Standalone» führt ABV abermals eine neue Produktkategorie ein. Anmutige, erschwingliche und umweltfreundliche Lösungen, die ohne großen Aufwand aufzustellen sind, die die Raumfunktion sofort verbessern und sich in die vorhandene Ausstattung integrieren. Eingesetzt, um akustische, ästhetische oder funktionale Probleme zu lösen, werden sie den Raum auf und werden schnell zu einem identitätsstiftenden und vertrauten Merkmal.

**NL**

Met de «Stand-Alone» collectie introduceert ABV een nieuw innovatief productengamma. Aan de hand van eenvoudige, betaalbare en ecologische oplossingen, die daarenboven snel en makkelijk te monteren zijn, worden bestaande werkruimtes in een handomdraai akoestisch verbeterd.

Hierdoor kunnen wij akoestische, esthetische en functionele problemen aanpakken en ruimtes een nieuwe, optimale functionaliteit en uitstraling geven.

**EN**

With the Stand-Alone items ABV once again defines and launches a new range of products. Light, affordable and ecological items, designed to be easily installed and to improve the existing workspace and facilities.

Introduced to solve any acoustic, aesthetic or functional problem, they qualify the space where they are and quickly become an identifiable and familiar landmark.

**Stand-Alone**



**Swell**  
P 34-35

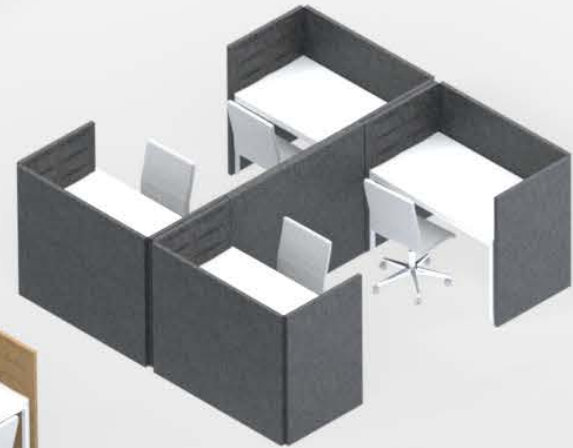

**Nautil**  
P 30-31



**K Bench**  
P 28-29



**Deskmate**  
P 38-41

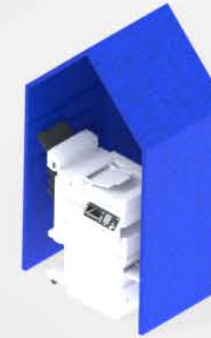

**Cabanes**  
P 42-45



**Side Panels**  
P 36-37

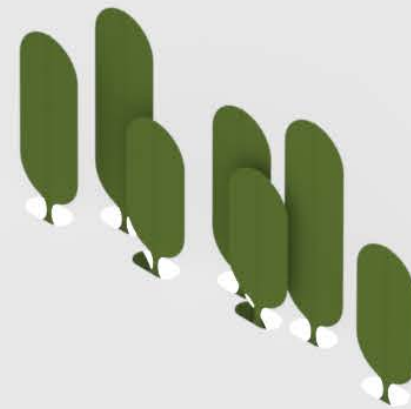

**Albero**  
P 32-33



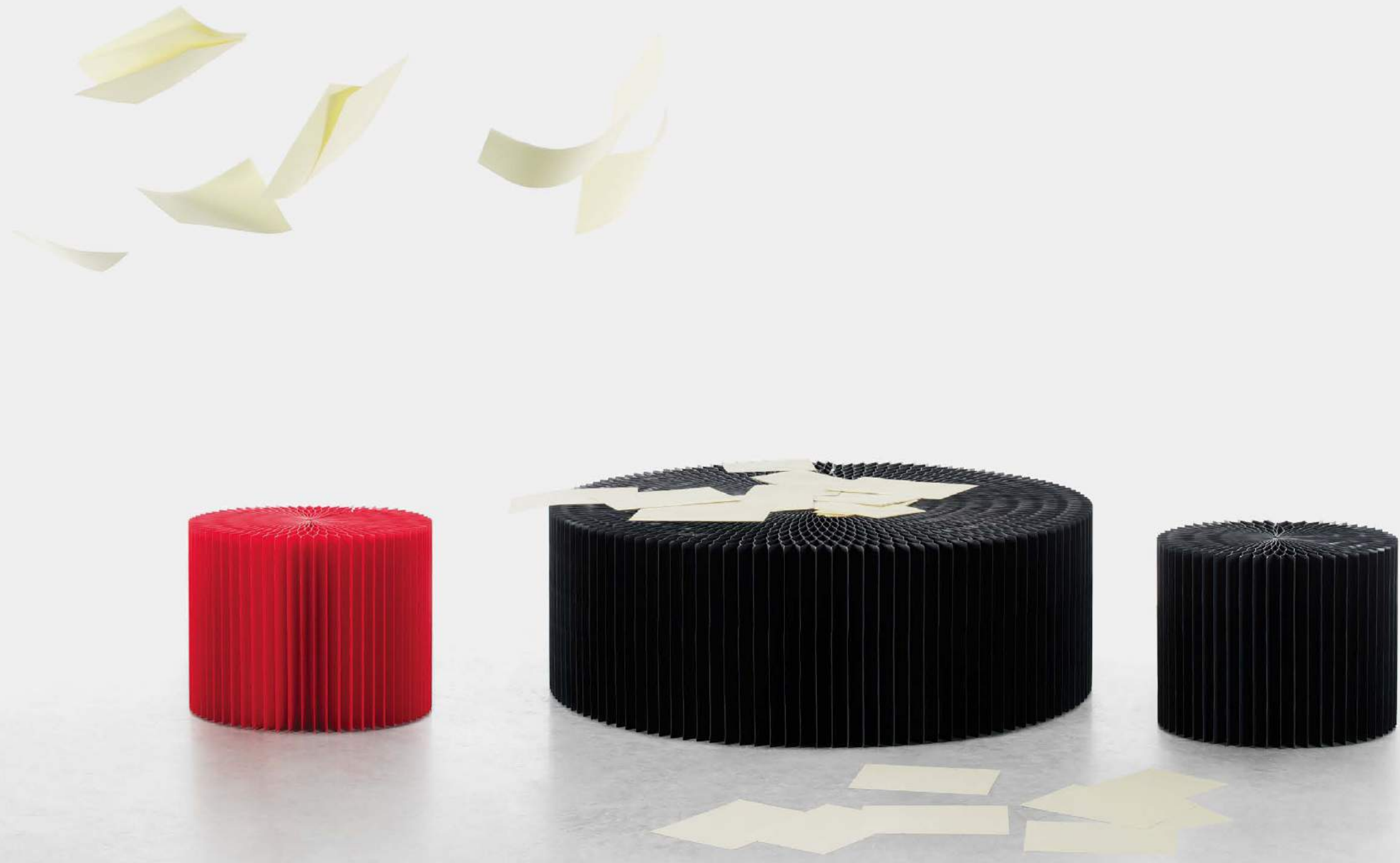

**ABV**

We design silence®

**Stand-Alone**

**Nautil** design by Michael Kruijne









**ABV**

We design silence®

**Stand-Alone**

**Swell** design by Hélène Boul









**ABV**

We design silence®

**Stand-Alone**

**Deskmate** design by Alain Berteau





**ABV**

We design silence®

**Stand-Alone**



**Deskmate** design by Alain Berteau





**ABV**

We design silence®

**Stand-Alone**

**Cabanes** design by Alain Berteau

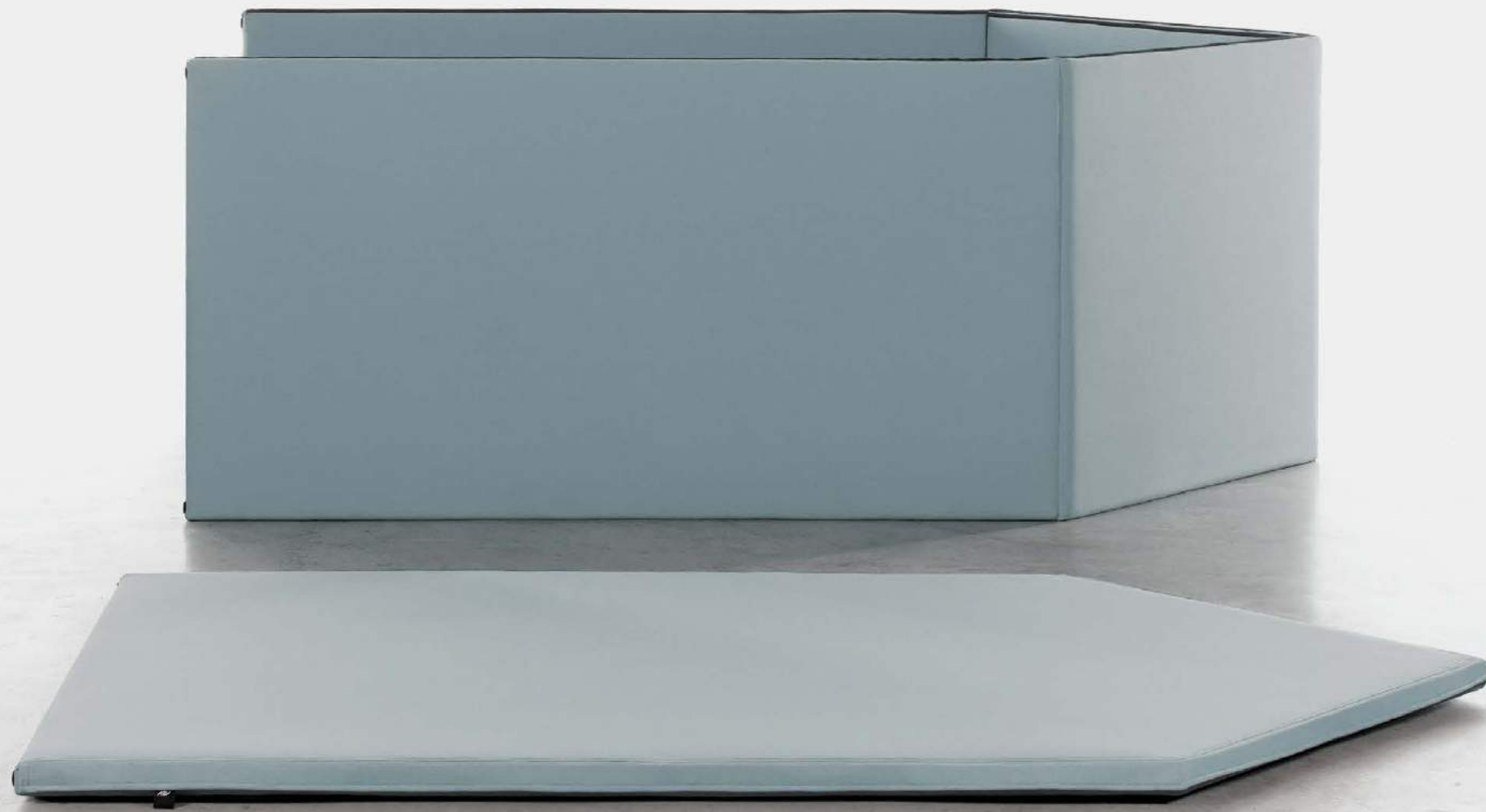







**ABV**

We design silence®

## Screens

**FR**

Les systèmes de cloisons en profils d'aluminium ABV bénéficient de 30 ans d'expertise internationale en matière de structuration d'espace et de maîtrise acoustique. Solides, simples et évolutifs, ils offrent un degré de personnalisation et d'accessoirisation inédit sur le marché, et accompagnent les meilleurs architectes internationaux dans leur souhait de concevoir des espaces de travail performants, élégants et confortables.

A l'instar des cloisons, Les panneaux-écrans ABV reposent sur une expertise trentenaire et sont une référence de marché. Ils habillent de nombreux projets sur le plan esthétique, privatif et acoustique. Garnis de tissus, mélamine, vitrés, avec ou sans support accessoires, à structure visible ou non, ils peuvent être adaptés à de nombreux types de bureaux. Offrant une très grande facilité de montage, ils sont incontournables dans l'organisation des plateaux de bureaux, call-center et autres espaces paysagers.

**DE**

In die Fertigung von Stellwandsystemen mit Aluminiumprofilen fließen 30 Jahre internationale Erfahrung in Sachen Raumgliederung und Akustik ein. Solide, einfach und anpassungsfähig, bieten ABV-Produkte einen auf dem Markt noch nicht dagewesenen Grad an Individualisierungsmöglichkeit, auch durch den Einsatz von Zubehör. Sie begleiten die besten internationalen Architekten bei ihrer Aufgabe, leistungsfähige, elegante und komfortable Arbeitsräume zu entwerfen.

Ebenso wie die Trennwände beruhen die Aufsatzblenden von ABV auf einem dreißigjährigen Fachwissen und gelten als Marktreferenz. In zahlreichen Projekten geben Sie in punkto Akustik und Privatsphäre den Ton an. Entweder mit Stoff bezogen oder in Melamin oder Glas gefertigt, mit oder ohne Zubehör-Träger, die Trennwände können in einfacher Weise auf vielen verschiedenen Büros angebracht werden. Durch ihre Effizienz und einfache Montage sind sie unentbehrlich bei der Gestaltung von Großraumbüros, Call-Center und anderen Räumlichkeiten.

**NL**

ABV beschikt over een jarenlange expertise op het gebied van systeem-scheidingswanden t.b.v. ruimtelijke indeling met de nadruk op vormgeving en akoestiek. Stabiel, eenvoudig en modulair bieden ze een ruime mogelijkheid tot individualisering om zo tot een optimale werkomgeving te komen. Net als de wanden genieten de opzetwanden van ABV van een 30 jaar lange expertise en zijn dusdanig een marktreferentie.

Ze geven vorm aan esthetiek, akoestiek en privacy in talloze projecten.

Gestoffeerd of niet, afgewerkt met laminaat of glas, met of zonder accessoires, kunnen ze op verschillende werktafels gebruikt worden. Ze bieden veel montagegemak en zijn zo goed als onontbeerlijk in het organiseren van Open Spaces en Call Centers.

**EN**

The ABV screening systems made out of aluminium profiles count over 30 years international expertise in space planning and acoustic mastery. Strong, easy to install and evolving systems, which can be custom-made and include a wide range of accessories in order to respond to the requirements of international architects and help them creating better, elegant and comfortable work environment.

ABV's Desktop screens can rely on a 30 year long expertise and are known as a market reference. They shape aesthetic, visual and acoustic privacy in many projects and in different styles. Upholstered or finished with laminated panels, glass. With or without accessories holders, they can be used on different kinds of benches. Easy to mount, they are a basic item in the organization of open spaces, call centers ...



Screens

**System DB75**  
P 70-71



**Nomad**  
P 54-55



**P25**  
P 52-53

**FIT System**  
P 56-57



**LC1 / LC3**  
P 50-51



**System 43**  
P 66-69



**System 37**  
P 62-65

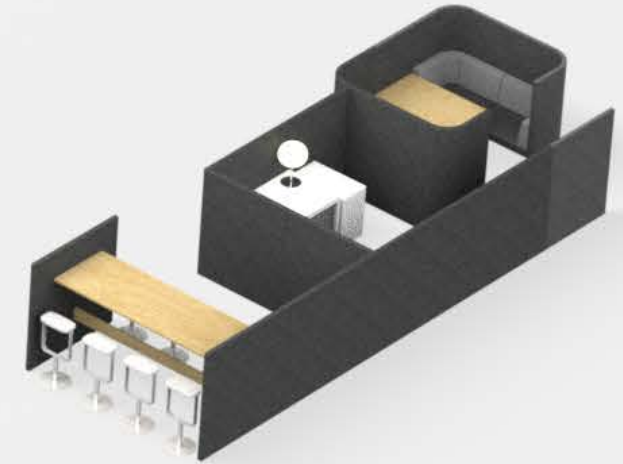

**FIT System**  
P 58-61





**Desktop Screens LC1**



**LC3**







Desktop Screens



Nomad











**Screens**



**FIT System**





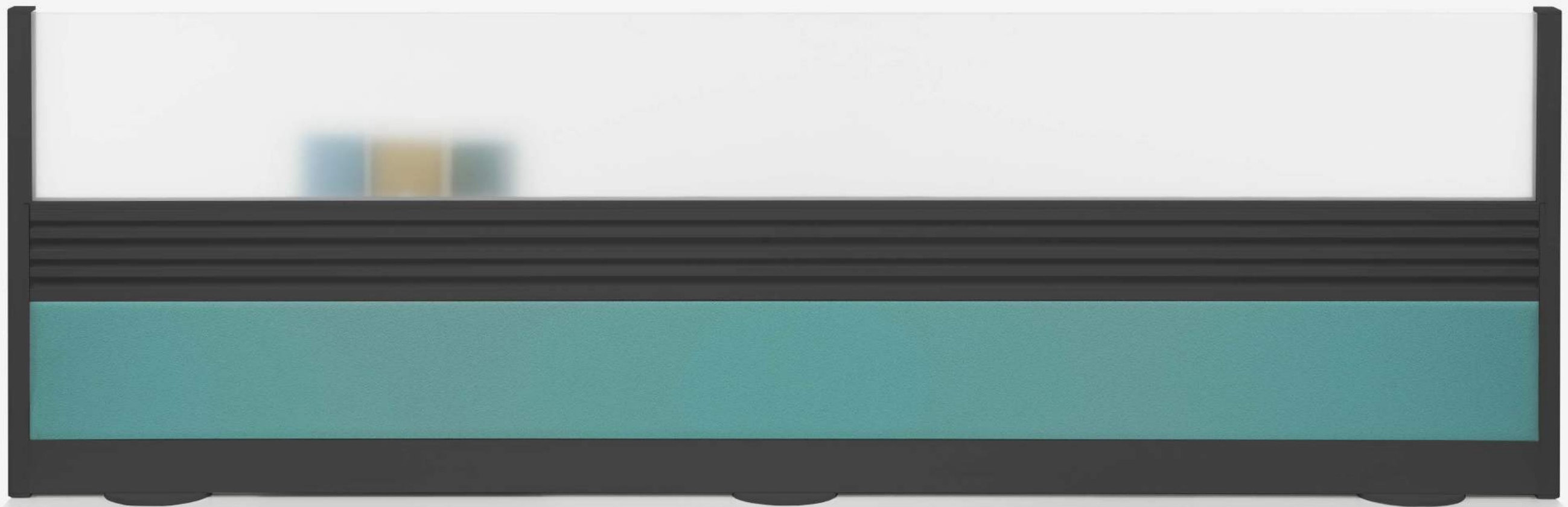

**Screens**



**System 37**







**ABV**

We design silence®

**Screens**

**System 43**





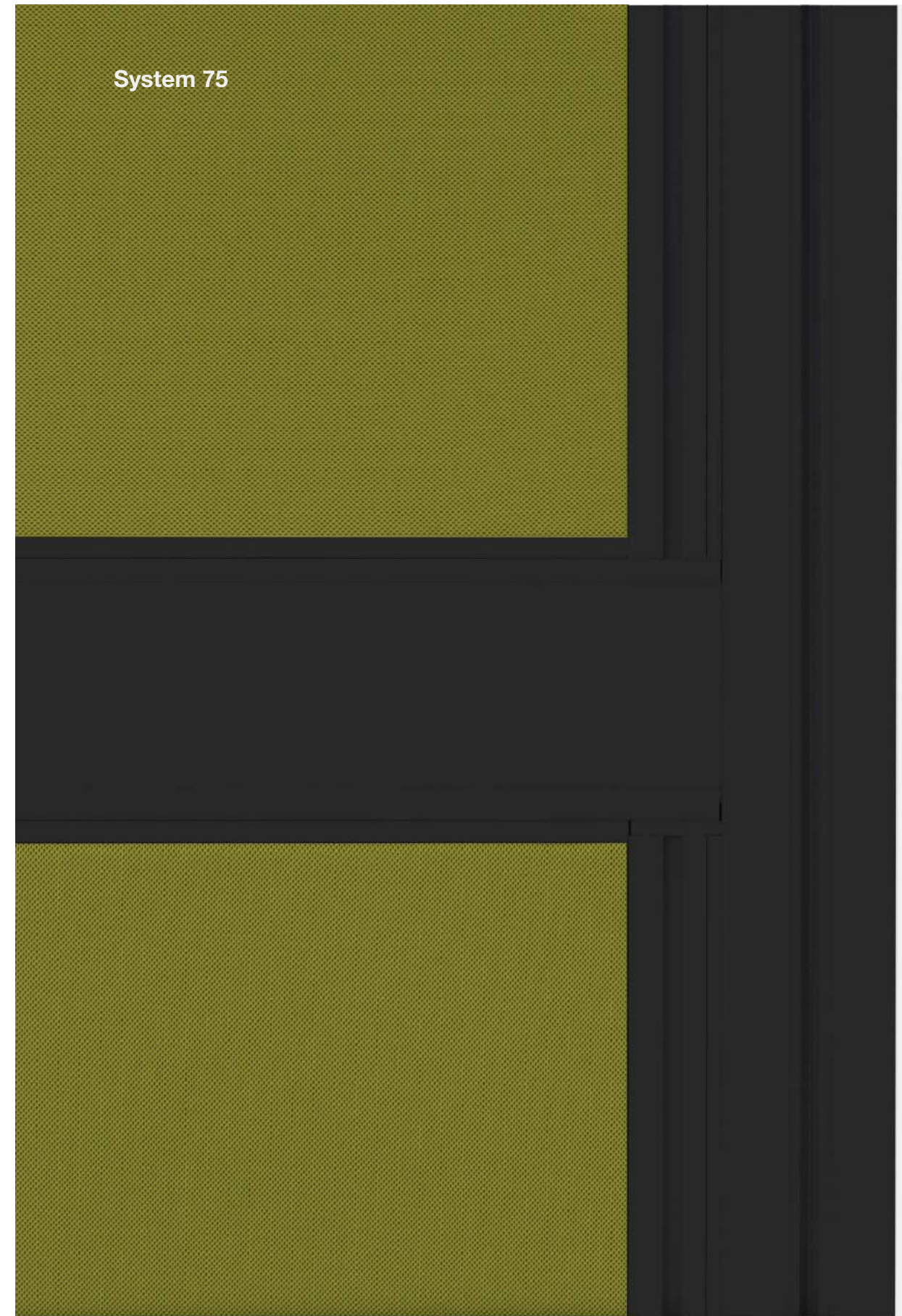



**ABV**

We design silence®

**Surfaces****FR**

SURFACES est la nouvelle collection de panneaux acoustiques dessinée par Alain Berteau et Julien Renault. Ces solutions suspendues, murales ou autonomes transforment chaque espace de travail, petit ou grand, en un magnifique paysage graphique et coloré. Cet alphabet de formes se caractérise par la simplification d'éléments familiers et identifiables. Les différents formats qui composent la collection s'assemblent rapidement et s'adaptent à tous les supports.

**DE**

SURFACES, die neue Produktreihe, entworfen durch Alain Berteau und Julien Renault, besteht aus Wandpanelen, vertikal hängenden Deckenpanelen und Stellwänden. Sie ermöglichen die Verwandlung jedes Arbeitsraumes, ob klein oder groß, in eine schöne, bunte und grafische Landschaft. Die unterschiedlichen Formen, aus denen sich die Produktreihe zusammensetzt, bieten Flexibilität und sind einfach montierbar. Sie können an allen Decken- und Wandoberflächen befestigt werden.

**NL**

SURFACES is een nieuwe collectie akoestische panelen naar een ontwerp van Alain Berteau en Julien Renault. Hangend aan de muren, of vrijstaand, kunnen ze om het even welke ruimte, groot of klein, in een kleurrijk grafisch landschap veranderen. SURFACES biedt een vorm en taal met eenvoudig te herkennen elementen, waar men zich snel thuisvoelt. De verschillende formaten laten zich makkelijk combineren, op om het even welke oppervlakte.

**EN**

SURFACES is the new acoustic panel collection designed by Alain Berteau and Julien Renault. It is an alphabet of simple, versatile and familiar shapes, easy to combine and to install on any support. Hanging, wall-mounted or freestanding, they turn any room into a colorful and meaningful landscape, offering a silent and very comfortable home feeling.



**Surfaces**

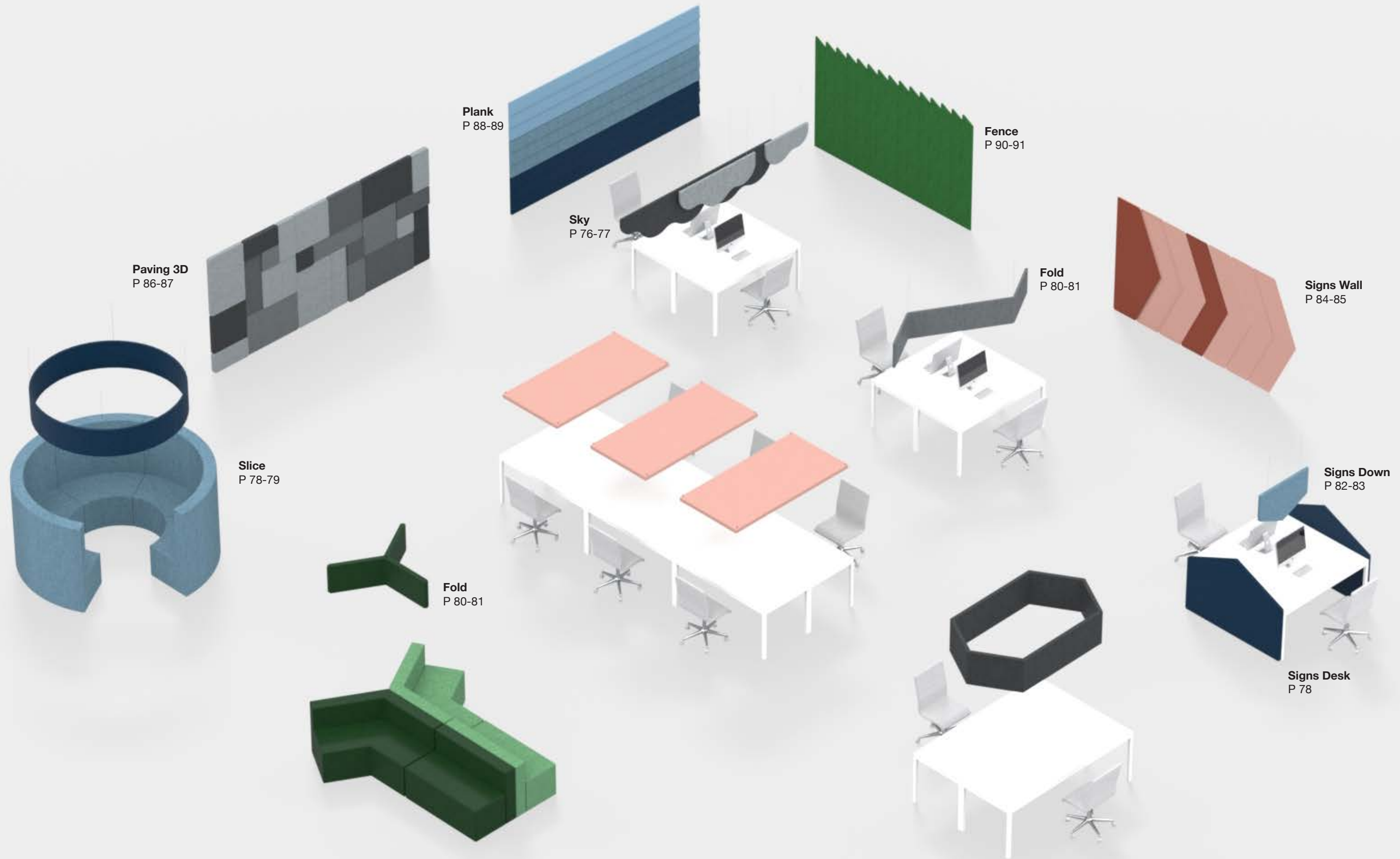

**ABV**

We design silence®

**Surfaces**

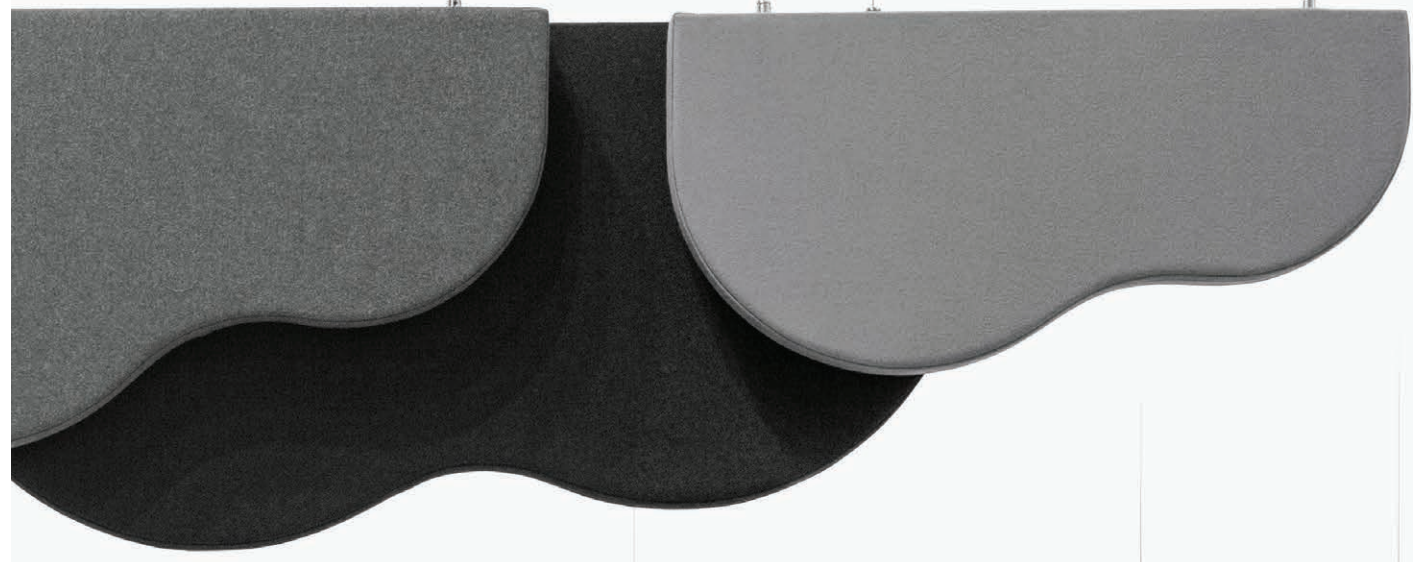

**Sky** design by Julien Renault

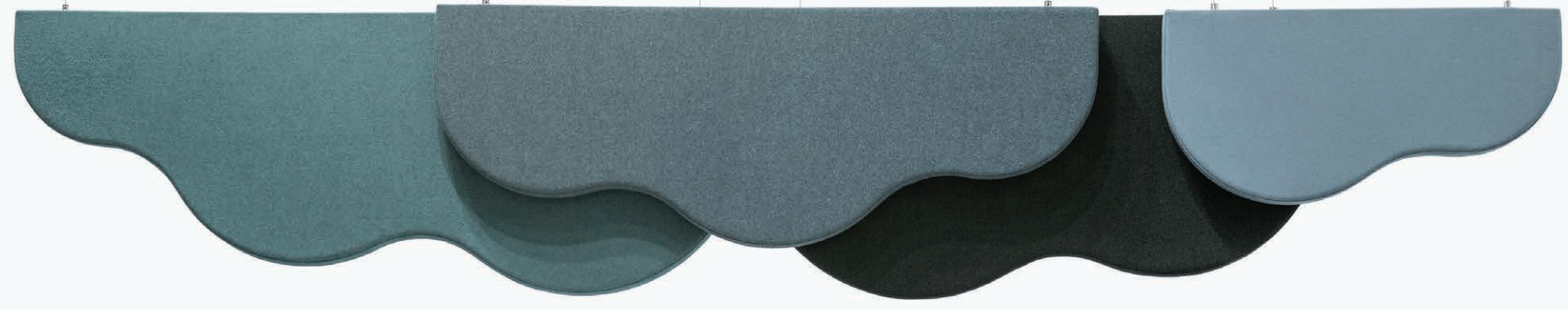
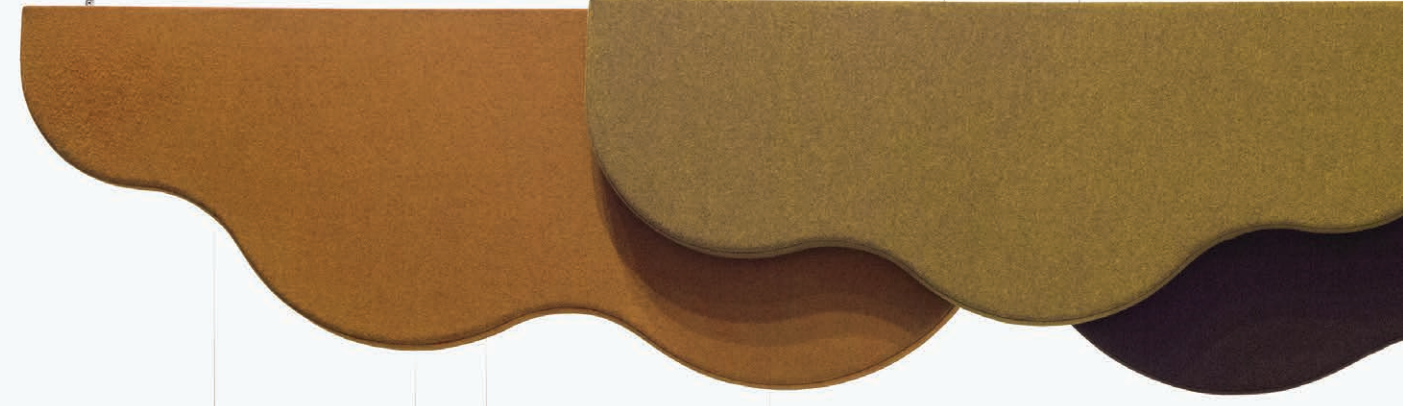



**ABV**

We design silence®

**Surfaces**



**Slice** design by Alain Berteau



**ABV**

We design silence®

**Surfaces**



**Fold** design by Julien Renault





**Surfaces**



**Signs Desk / Down** design by Alain Berteau





**ABV**

We design silence®

**Surfaces**

**Signs Wall** design by Alain Berteau





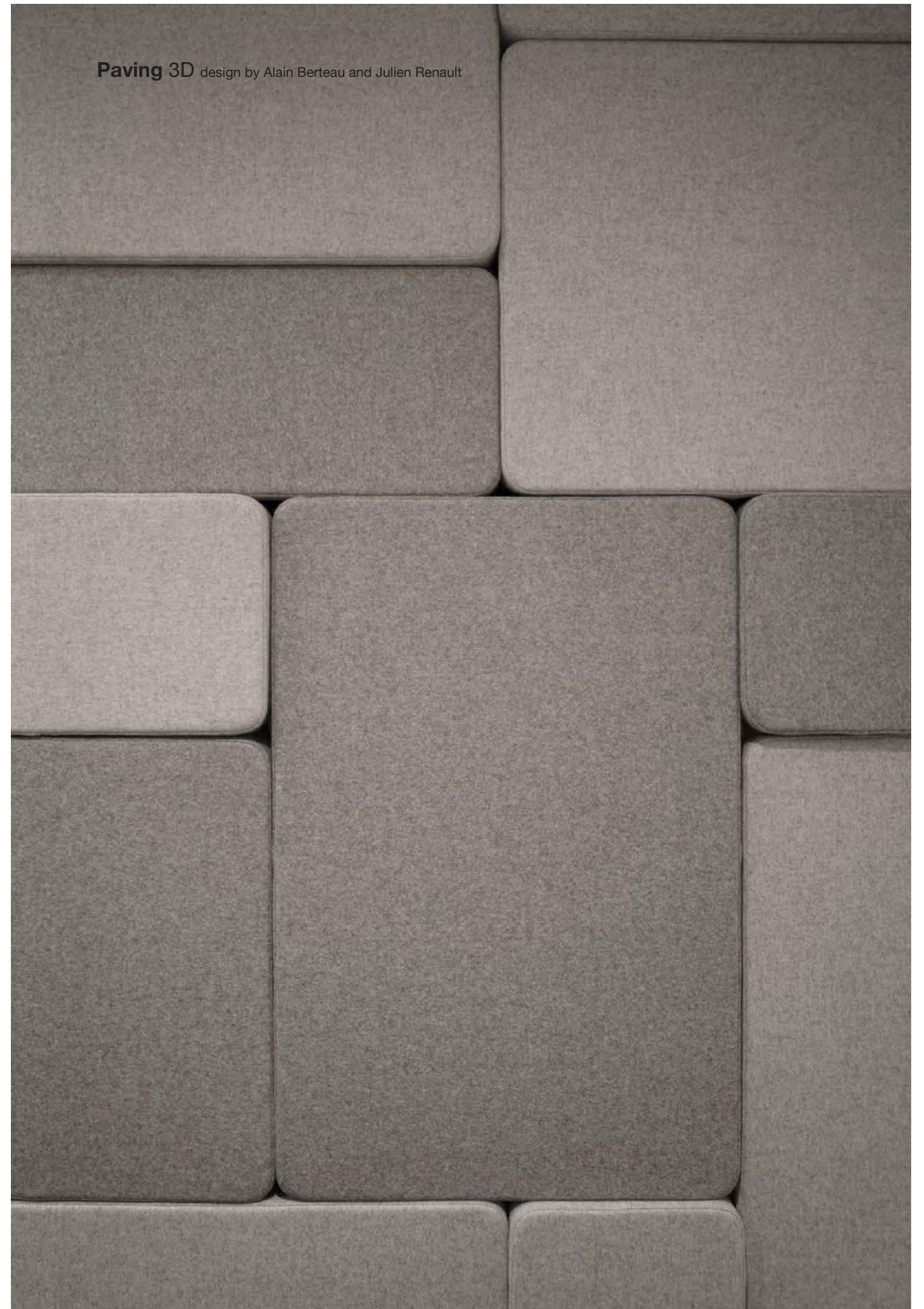



**ABV**

We design silence®

**Surfaces**

**Plank** design by Julien Renault









**ABV**

We design silence®

## Lounge System

**FR**

Considérés comme une référence du marché, les systèmes «Lounge» d'ABV sont constitués de modules simples, aux lignes fortes et essentielles. Des modules intelligents qui permettent de créer d'innombrables configurations : salles de réunions, salles d'attente, salons, bureaux isolés... Des espaces agréables et accueillants, à l'acoustique maîtrisée, et aux finitions impeccables.

**DE**

Die als Referenz am Markt geltenden Lounge-Systeme von ABV bestehen aus schlichten Modulen, die durch ihre kräftige und individuelle Linienführung bestechen. Intelligente Module, die es erlauben, unendlich viele Konfigurationen zu kreieren: Versammlungssäle, Wartebereiche, Räume für Empfang und Meeting, einzelne Büros... Angenehme und einladende Raumgestaltung, akustisch wirksam, in einwandfreier Verarbeitung.

**NL**

De «Lounge» systemen van ABV worden aanzien als DE referentie in de markt, bestaande uit strak, rechtlijnig vormgegeven modules. Aan de hand van deze modulaire elementen kan men onbegrensd blijven configureren : landschapskantoor, individuele werkplek, vergaderruimte, wachtruimte, ... aangename & uitnodigende ruimtes, met optimale akoestische waarden en met een zeer hoog afwerkingsniveau.

**EN**

Seen as THE reference on the market, the «Lounge» systems from ABV are composed out of simple shapes, with essential and strong lines. Clever units allowing countless layouts and uses: board room, waiting areas, single work station... Pleasant and welcoming areas, where acoustics are under control, where the finish is just perfect.



**Lounge System**

**eMood**  
P 108-111



**Mood Wall**  
P 98-101



**Mood Tube**  
P 118-119

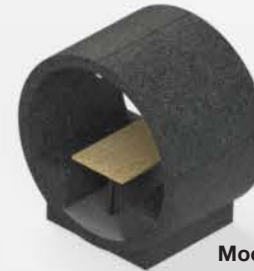

**Mood Wall**  
P 98-101



**Mood Screen**  
P 102-105



**Mood Lounge**  
P 96-97

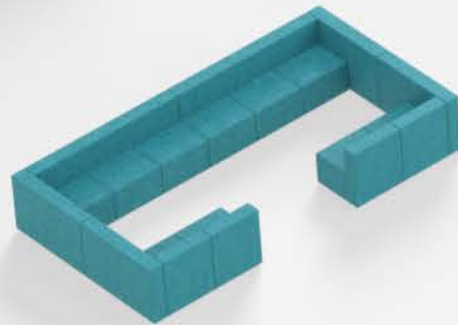

**Mood Slice**  
P 112-117



**Mood Star**  
P 106-107



**ABV**

We design silence®

**Lounge System**

**Mood Lounge** design by Alain Berteau





**ABV**

We design silence®

**Lounge System**

**Mood Wall** design by Alain Berteau





**ABV**

We design silence®

**Lounge System**

**Mood Wall** design by Alain Berteau





**ABV**

We design silence®

**Lounge System**

**Mood Wall** design by Alain Berteau



**ABV**

We design silence®

**Lounge System**

**Mood Screen** design by Alain Berteau





**ABV**

We design silence®

**Lounge System**

**Mood Screen** design by Alain Berteau



**Lounge System**

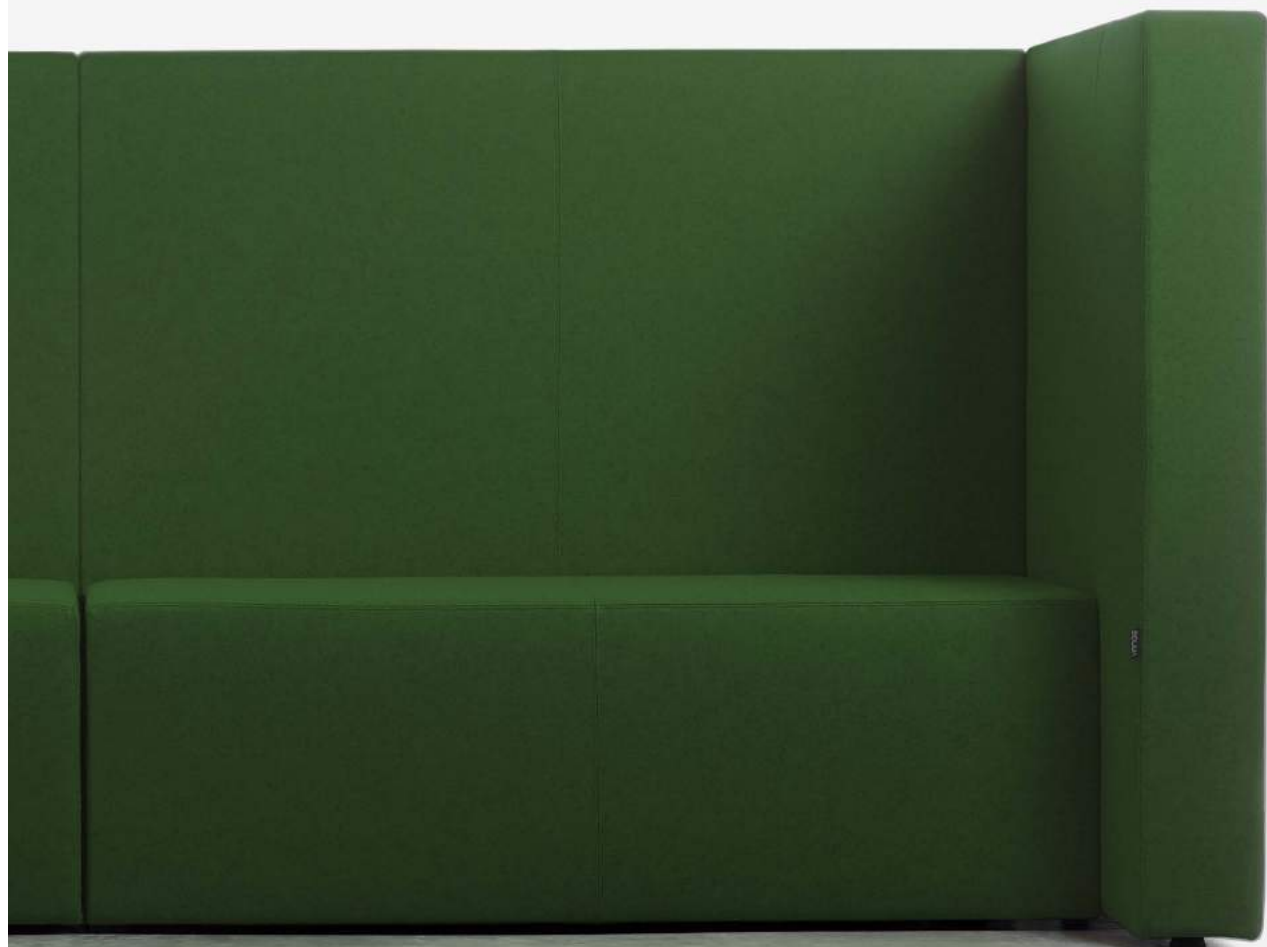

**Mood Star** design by Alain Berteau

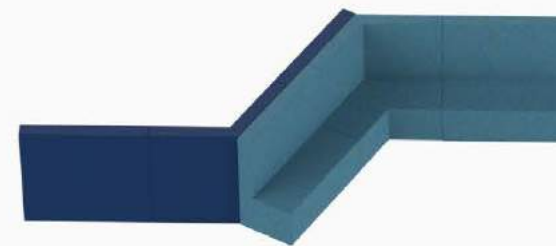
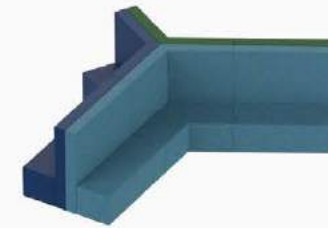



**ABV**

We design silence®

**Lounge System**

**eMood** design by Alain Berteau

in partnership with **WAVE**  
INSIDE  
CREATOR OF EFFICIENT MEETING SPACES





**ABV**

We design silence®

**Lounge System**

**eMood** design by Alain Berteau

in partnership with **WAVE**  
INSIDE  
CREATOR OF EFFICIENT MEETING SPACES

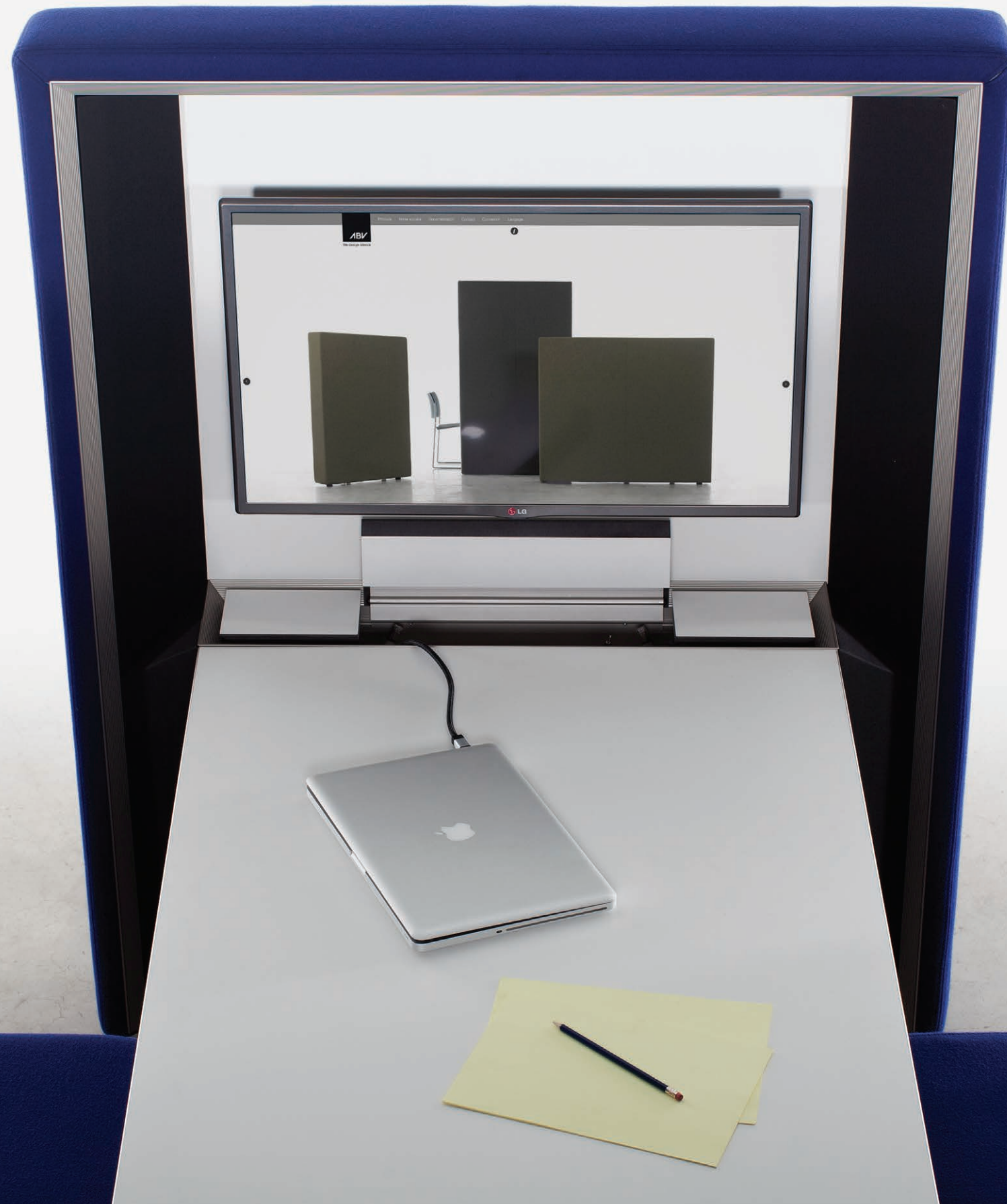



**ABV**

We design silence®

**Lounge System**

**Mood Slice** design by Alain Berteau



**ABV**

We design silence®

**Lounge System**

**Mood Slice** design by Alain Berteau





**ABV**

We design silence®

**Lounge System**

**Mood Slice** design by Alain Berteau



**Lounge System**





**ABV**

We design silence®

**Liège** Belgium







We design silence®