

executive

o5



GENESIS
collection

executive

05



GENESIS
collection

codutti

L'ufficio rappresenta la tua identità, il percorso che stai compiendo e i valori che ti accompagnano.

Comfort, tecnologia e funzionalità contribuiscono al tuo benessere e facilitano la riuscita delle attività che ti vedono protagonista nella vita lavorativa.

Noi di Codutti, dal 1954 artigiani e industriali insieme, creiamo soluzioni d'arredo per ufficio di alta gamma con l'attenzione e la cura frutto di oltre sessant'anni di esperienza nella produzione e nel design made in Italy, per le aziende, per gli studi professionali e i progetti contract, anche sui mercati internazionali.

Tutte le nostre collezioni – dagli arredi direzionali agli operativi, dalle sedute alle pareti divisorie – nascono dall'unione di artigianalità e innovazione tecnologica e si contraddistinguono dall'alto livello di qualità e cura del dettaglio propri del marchio Codutti.

La flessibilità per noi è un valore: prendiamo in carico i tuoi progetti e siamo al tuo fianco nel fornire soluzioni personalizzate che superano le tue aspettative.

Un ufficio unico e coinvolgente, che ti emoziona ogni giorno.

Your office shows who you are, what your journey is and your principles are.

Comfort, technology and functionality: all contribute to your wellness and make easier those tasks that see you as the main actor in your daily business life.

We at Codutti have been both craftsmen and industrialists since 1954; we create design solutions for the highline office, paying the attention for the detail we have learned from more than sixty years of experience with the made in Italy production and design.

It's for companies, for professionals and contract projects, also on global markets.

All our collections - from the executive to the operative office, from the chairs to the partition walls - are born from the union between craftsmanship and technology innovation, and stand out thanks to high quality level and care for details, which has always been the main distinction of the Codutti brand.

We believe flexibility is an added value: we take in your project requests and stand at your side to give you customized solutions that go beyond your expectations.

A unique appealing office that excites you day after day.

INDEX

01



Wengé | Moka | Cream

p. 8

03



Oak | Dove grey

p. 16

05



Oak | Natural | Plum Red

p. 24

07



Oak | Cream | Moka

p. 32

02



Glass | White | Gunmetal

p. 12

04



Glass | Ochre | Wengé

p. 20

06



Wengé | Black | Ochre

p. 28

08

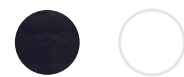

Wengé | White

p. 36

09



Glass | Carbon | White | Gunmetal

p. 40

11



Oak | Blue

p. 48

13



Glass | Oak | Cream

p. 56

10



Wengé | Cream | Moka

p. 44

12



Wengé | Cream

p. 52

Genesis

raffinatezza, tecnologia, dinamicità

Il graduale concretarsi e organizzarsi di un'opera d'arte nella mente dell'artista, con questa filosofia nasce Genesis, sintesi perfetta di raffinatezza, tecnologia e dinamicità.

Una collezione esclusiva disegnata dall'Architetto Tiziano Dainese & Valuenet associati che si contraddistingue per il design minimale e l'essenzialità delle linee. Segno distintivo della collezione, le gambe, costruite con una fusione di alluminio lucido con tre punti d'appoggio ciascuna per il supporto del piano, che garantiscono la perfetta stabilità delle scrivanie in tutte le loro varianti. Questa è anche disponibile nella variante elegante, rifinita verticalmente in cuoio cucito a punto sella. La loro finitezza si fonde perfettamente con i piani nella versione in legno costruito in MDF (medium density fibreboard) rovere da 30 mm, verniciato in tinta wengè o naturale; in vetro temperato da 12 mm, trasparente o serigrafato; e cuoio nella totalità cromatica offerta, cucito a punto sella e rifinito nei quattro spigoli con angolari in alluminio lucido e da un filo di luce in alluminio che attraversa il piano longitudinalmente.

In linea con questo stile esclusivo sono stati realizzate cassettiere, librerie, armadi, oltre ai versatili allunghi che ripropongono le stesse finiture dei piani.

The gradual creation and definition of an artwork in the imagination of the artist: this is the philosophy of Genesis, the right synthesis of the sophistication and dynamic technology.

An exclusive collection, designed by the architect Tiziano Dainese & Valuenet associati stands out for its minimal design and essential lines.

The legs, the signature element of the collection, are built with the melted shiny aluminium and have 3 support points each for the top that ensure the perfect balance for all kinds of desks. Legs are also available in more elegant version - vertically covered saddle-stitched thick leather. These elements match perfectly the wooden tops, made in MDF (medium density fibreboard) 30 mm thick oak, dyed in wenge or natural finish; or the ones in 12 mm tempered transparent or colored glass; or even in saddle stitched thick leather and decorated with angles in polished aluminium and shiny profile that crosses the top horizontally.

Drawers, bookcases, cabinets have been made in line with this exclusive style, as well as the versatile extensions that reproduce the same finishes of the tops.



01 WENGÉ | MOKA | CREAM





- A** Gambe indipendenti costruite in una robusta fusione di alluminio lucidato.
Independent legs made in melted shiny aluminium.
- B** Sottomano rivestito in cuoio con mostrina in inox.
Desk pad in leather with profile in stainless steel.
- C** Allungo laterale con top in legno e cassettera a tre cassetti.
Lateral extension with wooden top and three drawers cabinet.
- D** Consolle con anta a ribalta rivestita in cuoio.
Console with leather covered drop-leaf door.

Finiture | Finishes

- SW06** Legno | Wood
Rovere tinto wengé
Wengé dyed oak
- CM81** Cuoio | Thick leather
Moka
Moka
- CC82** Cuoio | Thick leather
Crema
Cream

Dati Tecnici | Technical Data

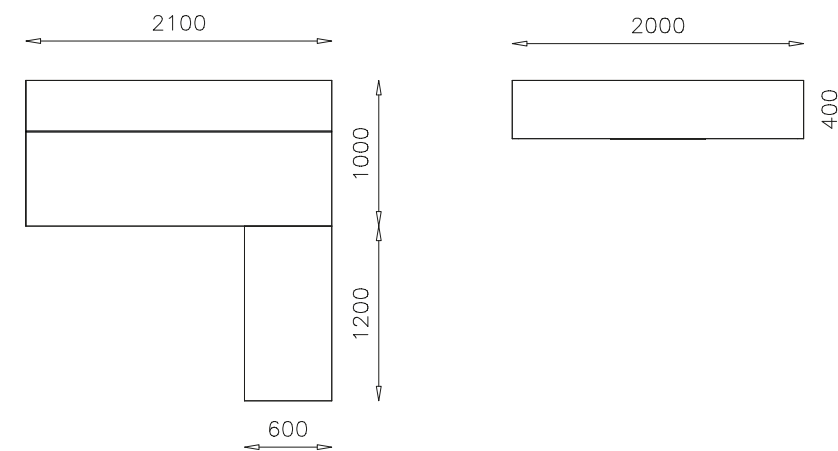

02 GLASS | WHITE | GUNMETAL





Finiture | Finishes



VE65
Vetro | Glass
Trasparente
Transparent



CJ83
Cuoio | Thick leather
Bianco
White



FP61
Laccato | Lacquered
Piombo
Gunmetal

Dati Tecnici | Technical Data

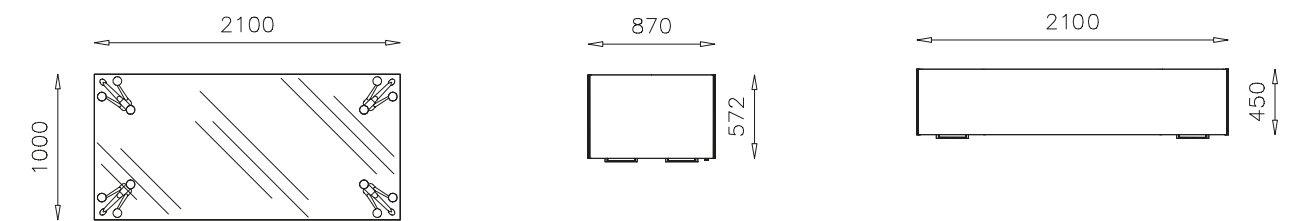

A Vetro temperato, spessore di 12 mm.
Tempered glass, 12 mm thick.

B Portapenne in inox con inserti in cuoio.
Pen holder in stainless steel with leather inserts.

C Raccogliacavi in cuoio.
Cable conduit in leather.

03 OAK | DOVE GREY





A Libreria con anta a ribalta in rovere naturale.
Bookcase with a drop-leaf door in natural oak.

B Mensola in cuoio con angolari in alluminio lucidato.
Leather covered shelf with shiny aluminium corners.



C Gamba rivestita in cuoio.
Leather covered leg.

Finiture | Finishes

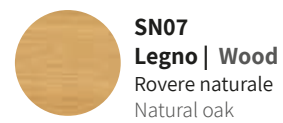

SN07
Legno | Wood
Rovere naturale
Natural oak



CT86
Cuio | Thick leather
Tortora
Dove grey

Dati Tecnici | Technical Data

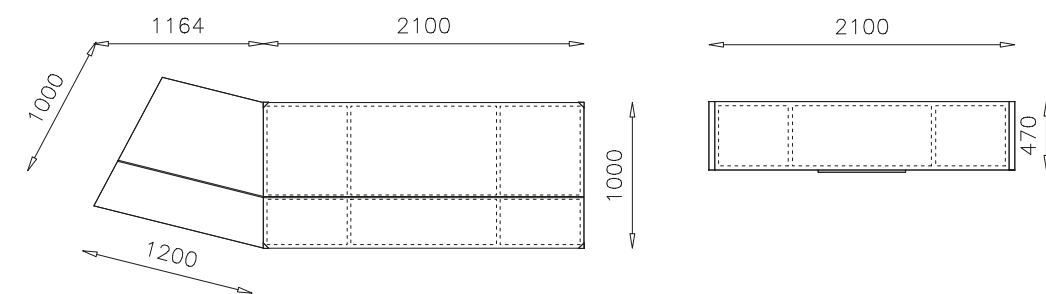

04 GLASS | OCHRE | WENGÈ





Dati Tecnici | Technical Data

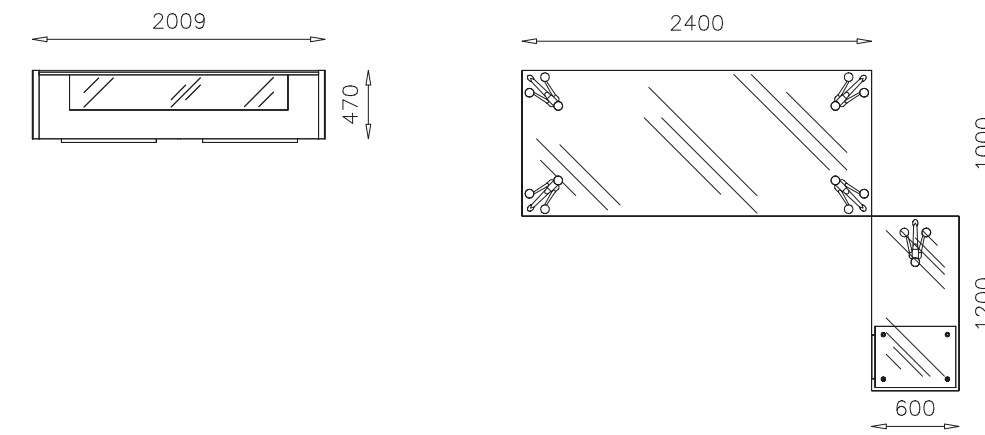

Finiture | Finishes

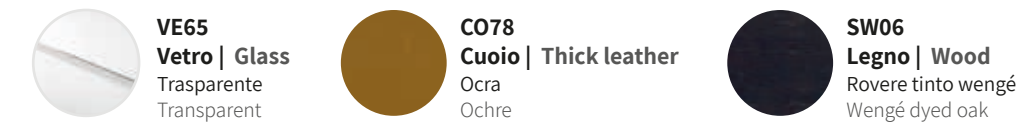

A Libreria disponibile nella versione con coppia di cassetti oppure con anta a ribalta.
Bookcase available with two drawers or drop-leaf door.

B Mensole in vetro.
Glass shelves.

C Sottomano protettivo.
Protective desk pad.



Allungo su ruote disponibile in diverse combinazioni: cassetti, ante, vani a giorno con ripiano in vetro.

Extension on castors available in various combinations: drawers, doors, open cabinets with glass shelf.

05 OAK | NATURAL | PLUM RED





Allungo a coda di rondine con angolo di 45° rispetto alla scrivania.
Independent 45° angled dovetail extension from desk.

Finiture | Finishes

SN07
Legno | Wood
Rovere naturale
Natural oak

CB76
Cuoio | Thick leather
Naturale
Natural

CI71
Cuoio | Thick leather
Vinaccia
Plum red



Faretto incassato che proietta la luce verso il basso.
Built-in spotlight that projects light downwards.

Dati Tecnici | Technical Data

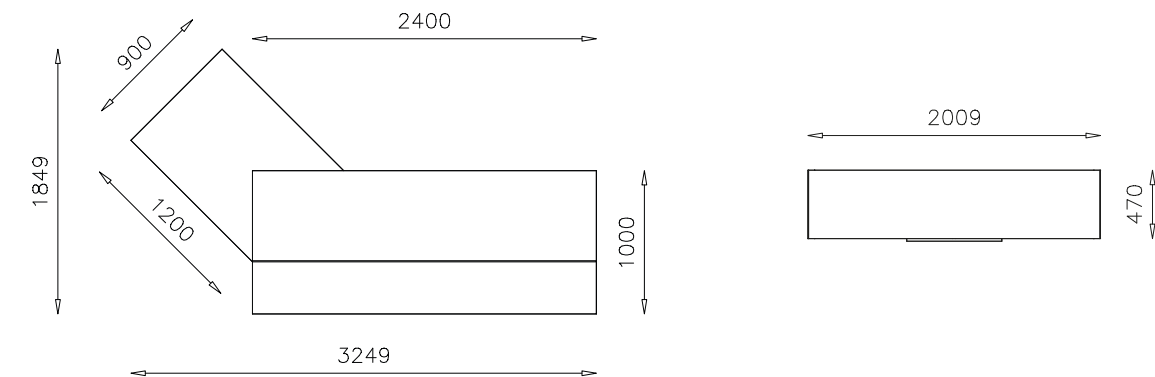

06 WENGÉ | BLACK | OCHRE



Anta in vetro satinato, intelaiata in alluminio lucido.

Satin glass door, framed in polished aluminium.



Dati Tecnici | Technical Data

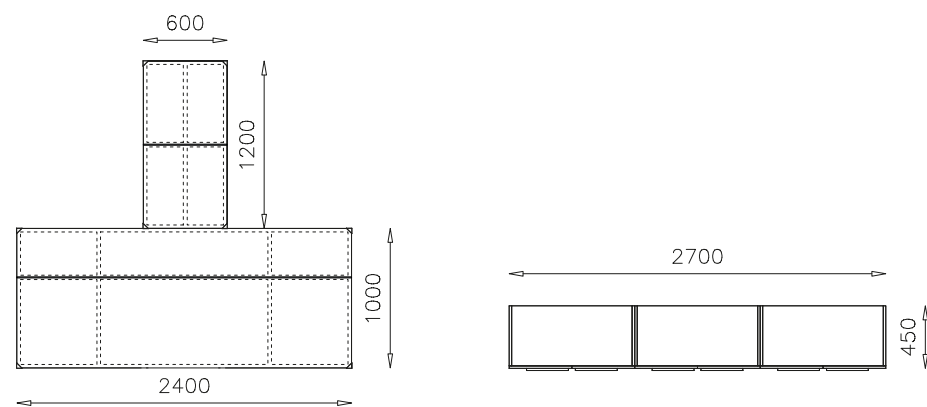

A Disponibili controfianchi di finitura.
Finishing counter sides available.

B Disponibile versione con cassetti porta cartelle.
Available version with folder drawers.

Finiture | Finishes

SW06
Legno | Wood
Rovere tinto wengé
Wengé dyed oak

CN72
Cuoio | Thick leather
Nero
Black

CO78
Cuoio | Thick leather
Ocra
Ochre

07 OAK | CREAM | MOKA





Libreria con ante battenti laterali e ribalta centrale.
Bookcase with hinged side doors and central drop-leaf door.

Finiture | Finishes

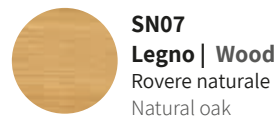

SN07
Legno | Wood
Rovere naturale
Natural oak



CC82
Cuio | Thick leather
Crema
Cream



CM81
Cuio | Thick leather
Moka
Moka



A Cassettiera in rovere naturale su ruote con portacancelleria estraibile.
Drawer in natural oak wood on castors with pull-our stationery tray.

B Poltrona in pelle crema con gamba in acciaio cromato.
Tub chair in cream leather with chromed steel legs.

Dati Tecnici | Technical Data

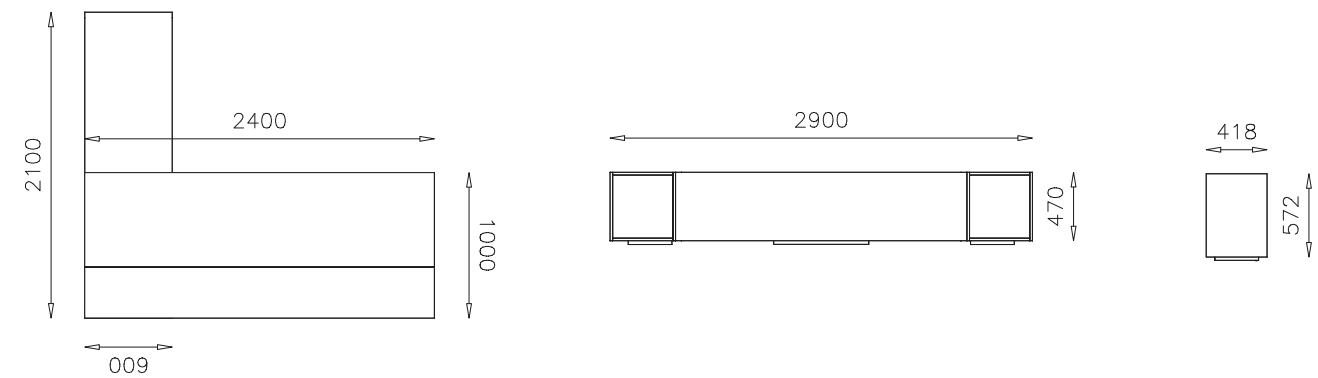

08 WENGÉ | WHITE





Tavolino d'attesa con base in legno e ripiano superiore in legno e cuoio o vetro. Colonnine in acciaio cromato.

Side table with wood base and wood, leather or glass top. Columns in chromed steel.

Dati Tecnici | Technical Data

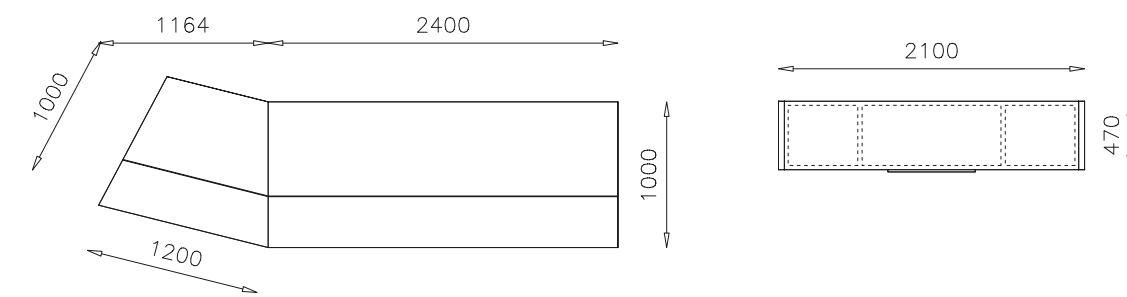

A Ribalta rivestita in cuoio.
Leather covered drop-leaf door.

B Allungo in legno con inclinazione di 15°.
Wood extension with 15° of inclination.

C Paragambe in legno con filoluce a terra.
Modesty panel in wood with low shiny profile.

Finiture | Finishes

SW06
Legno | Wood
Rovere tinto wengé
Wengé dyed oak

CJ83
Cuoio | Thick leather
Bianco
White

09 GLASS | CARBON | WHITE | GUNMETAL





Dati Tecnici | Technical Data

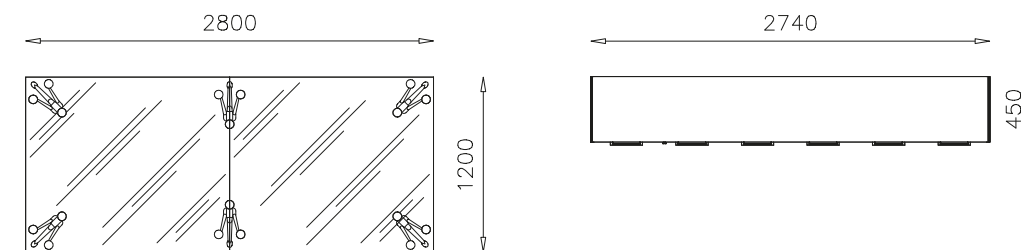

A Tavolo riunione in formato quadrato.
Squared meeting table.

B I tre punti di appoggio di cui sono dotate le gambe assicurano una perfetta stabilità.
Three support points of the legs ensure a perfect stability.

C Tavolo riunione in vetro temperato.
Meeting table in tempered glass.

Finiture | Finishes



10 WENGÉ | CREAM | MOKA



Sedia imbottita con retro e braccioli in cuoio e fronte in pelle, fisse o su ruote. Possibilità di abbinamento tra materiali e colori diversi nelle sedute.

Padded chair with armrests and rear-back in thick leather and front in thin leather, fixed or movable. Possibility of combining different materials and colors in the seats.



Appendiabiti con stelo cromato e dettagli rivestiti in cuoio.

Coat stand with chromed stalk and leather inserts.



Dati Tecnici | Technical Data

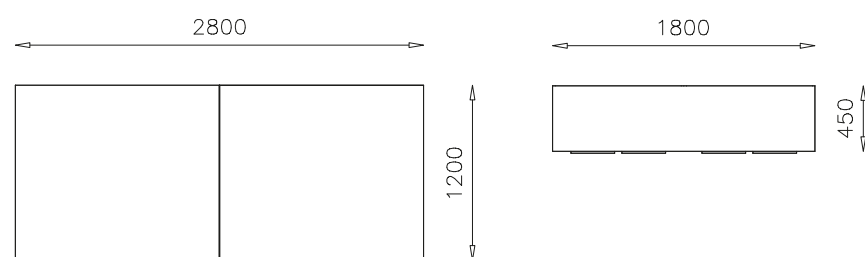

Finiture | Finishes

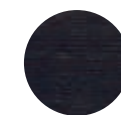

SW06
Legno | Wood
Rovere tinto wengé
Wengé dyed oak



CC82
Cuoio | Thick leather
Crema
Cream



CM81
Cuoio | Thick leather
Moka
Moka

11 OAK | BLUE





Dati Tecnici | Technical Data

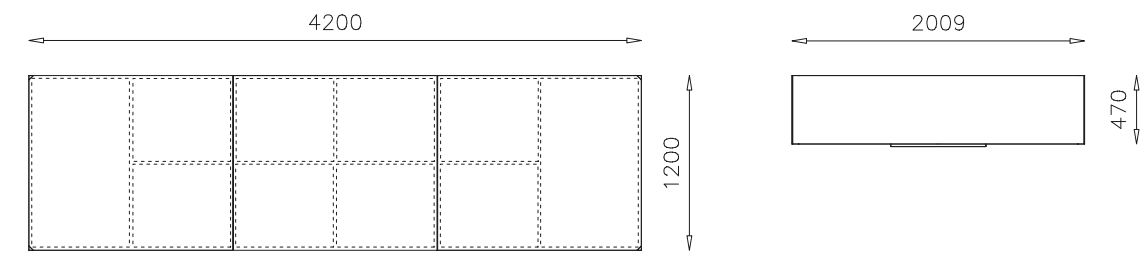

Tavolo riunione modulare in legno o rivestito in cuoio con filoluce cromato.

Modular meeting table in wood or covered in leather with chromed profile.

Finiture | Finishes

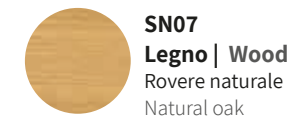

12 WENGÉ | CREAM



Finiture | Finishes

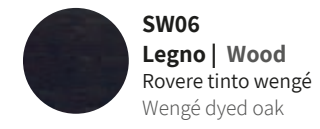

Dati Tecnici | Technical Data

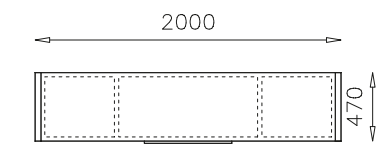
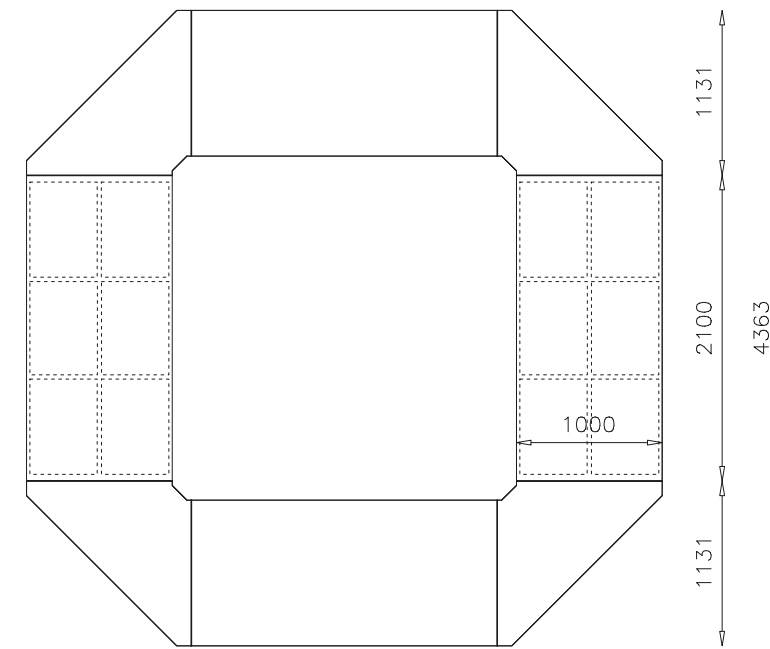
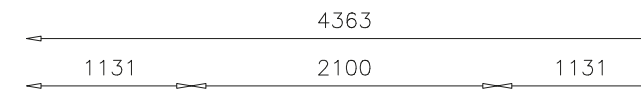

Tavolo componibile in legno, disponibile anche in cuoio. Frontali in legno con filoluce a terra.

Modular table in wood, also available in leather. Modesty panels in wood with low chromed profile.

13

GLASS | OAK | CREAM





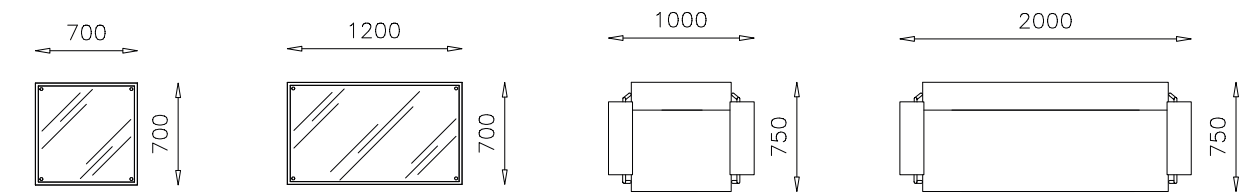

Dati Tecnici | Technical Data



Poltrone e divani in pelle con reggischienale in cuoio e struttura in metallo cromato.
Thin leather armchairs and sofas with the rear seat in leather and with a chromed structure.

Finiture | Finishes

- 

VE65
Vetro | Glass
Trasparente
Transparent
- 

SN07
Legno | Wood
Rovere naturale
Natural oak
- 

CC82
Cuoio | Thick leather
Crema
Cream

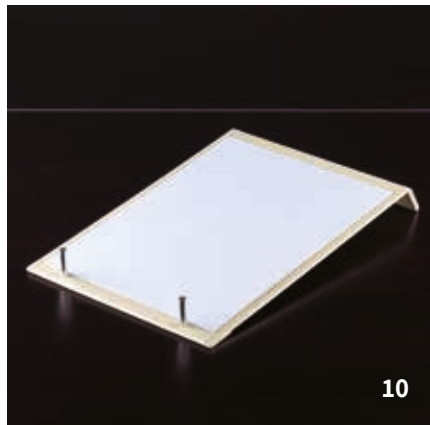
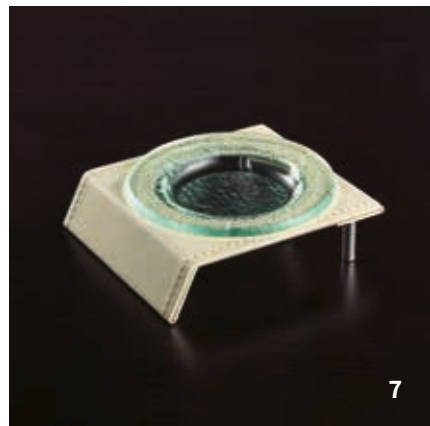

- 1** Sottomano centrale
Central desk pad
- 2** Sottomano in cuoio
Desk pad covered in leather
- 3** Sottomano in cuoio aperto
Open desk pad covered in leather
- 4** Portaoggetti
Object tray



- 5** Portaoggetti con divisori
Object tray with dividers
- 6** Portafoto
Photo frame
- 7** Posacenere
Ashtray
- 8** Orologio
Desk clock
- 9** Cestino
Wastepaper basket
- 10** Portacarte
Paper tray
- 11** Tagliacarte
Paper knife
- 12** Appendiabiti
Coat stand
- 13** Frigo
Built-in refrigerator
- 14** Cassaforte
Built-in safe
- 15** Specchio
Mirror
- 16** Quadro
Frame



Rainbow

I colori ed i loro abbinamenti esprimono chi sei. Poterli scegliere significa trovare la libertà di esprimersi e l'occasione di trasmettere un messaggio a chi ti circonda. Rainbow è il progetto che permette di personalizzare il colore di ogni collezione scegliendo tra le numerose finiture di cuoio previste nel Campionario Finiture Codutti.

The colours and the way they are matched tell who you are. Being able to choose them means having the freedom to express yourself and the chance to send a message to those around you. Rainbow is the project which permits personalizing the colour of every collection, choosing from among the numerous leather finishes in the Codutti Sample Book.

Legno | Wood

SN07
Rovere Naturale | Natural oak



SW06
Rovere tinto wengé | Wengé dyed oak



VE65
Vetro trasparente | Transparent glass



Vetro | Glass

Cuoio | Leather

CC82
Crema | Cream



CM81
Moka | Moka



DK46
Carbonio | Carbon

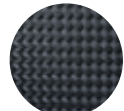

Il legno presente nelle collezioni direzionali Codutti è un materiale naturale. Per questo motivo differenze nelle caratteristiche cromatiche e di venatura presenti in ogni singolo elemento d'arredo, sono considerati segni distintivi di pregio.

Il cuoio e la pelle sono materiali diversamente trattati, quindi diversa è la rifrazione della luce che determina il tono del colore. Le cuciture di pelle e cuoio possono presentare irregolarità nel tratto e variazioni di linea. Pertanto differenze di tono del colore e lievi imperfezioni nelle cuciture devono essere accettate quale segno dell'unicità e della cura artigianale del prodotto. Codutti Furniture S.r.l. si riserva di apportare qualsiasi modifica alle Collezioni presenti in questo catalogo ogni volta che lo ritenga opportuno.

The wood in Codutti's executive collections is natural material. Any differences in terms of color and veining between individual pieces of furniture are therefore considered as characteristic and distinctive markings.

Thick leather and thin leather undergo different curing processes. As a result, the surfaces refract light differently and this determines a variation in the shade of the color. Moreover, the stitching in both thick and thin leather may appear irregular. Any differences in the shade of color and slight imperfections in the stitching are the natural consequence of the craftsmanship involved in the manufacturing process, which makes each product unique. Codutti Furniture S.r.l. is entitled to bring any modifications on Collections included in this catalogue at any time, without previous notice.

SCRIVANIE E ALLUNGHI | DESKS AND EXSTENSIONS

Top legno | Wood top

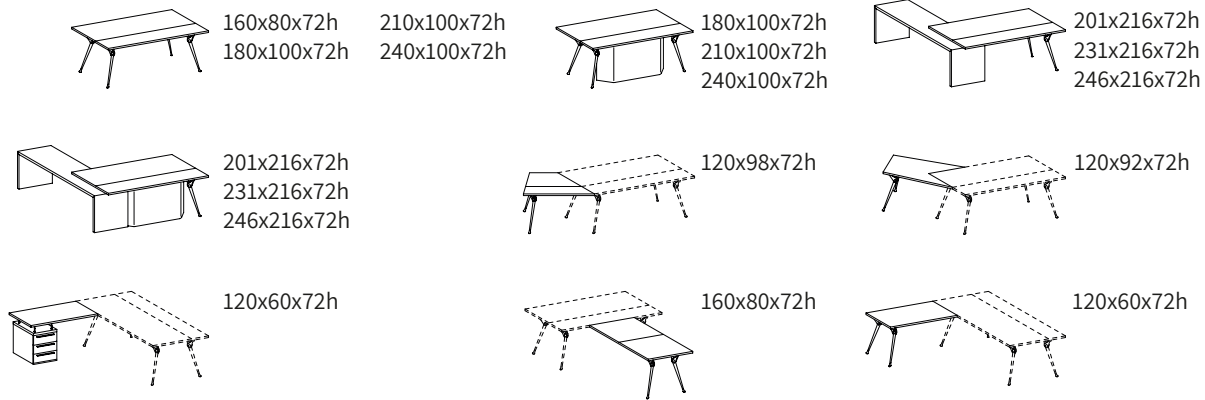

Top cuoio | Thick leather top

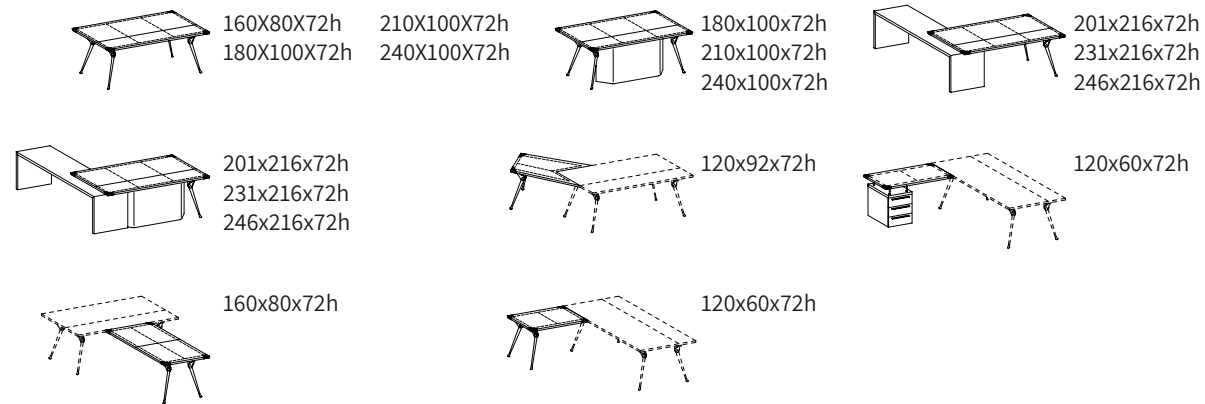

Top vetro trasparente | Transparent Glass top

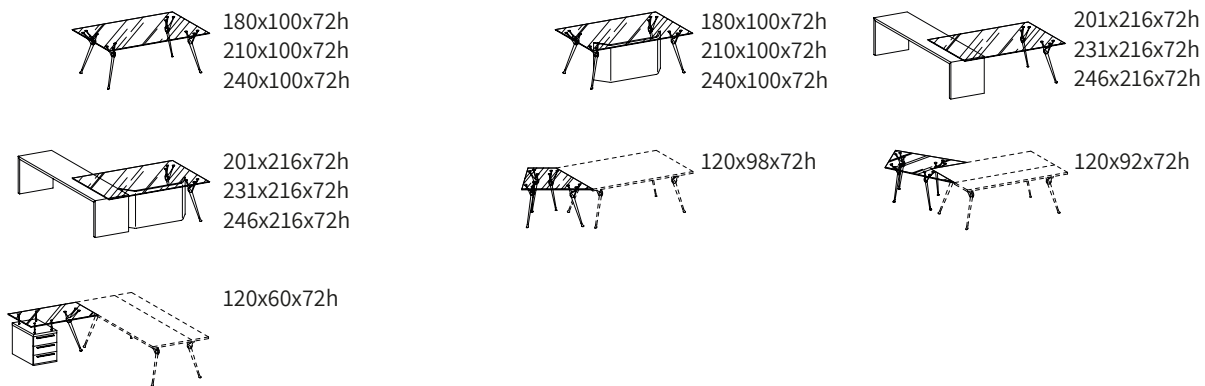

ARMADI | CABINETS

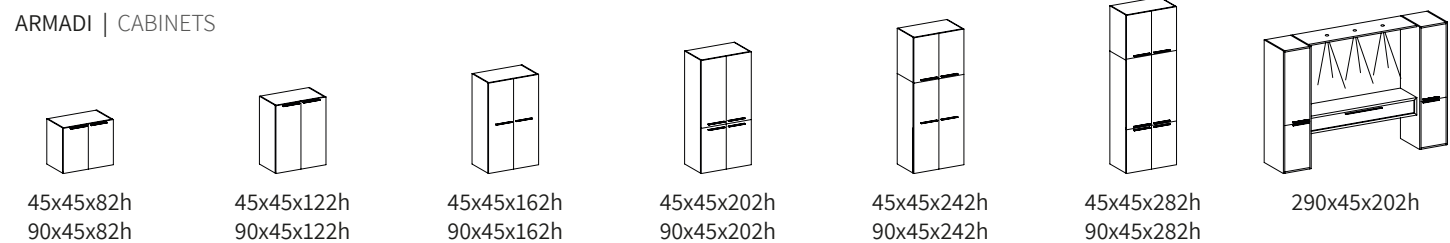

ALLUNGHI E CASSETTIERE | EXTENSIONS AND DRAWER UNITS

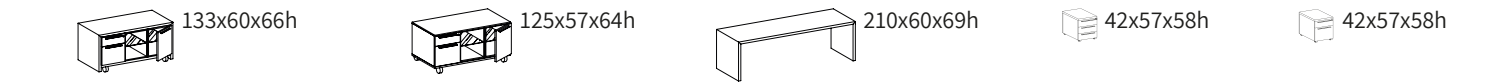

CONSOLE | CONSOLES

Legno | Wood

Cuoio | Thick leather

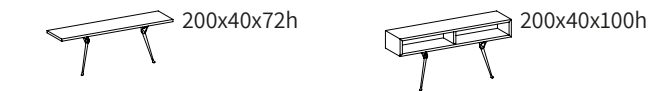

LIBRERIE | BOOKCASES

Legno | Wood

Cuoio | Thick leather

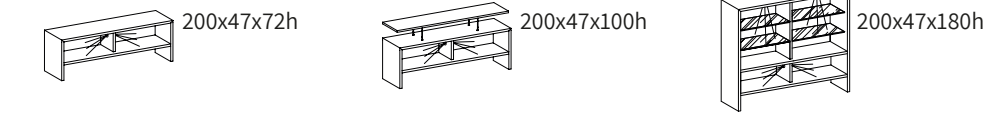

Vetro trasparente | Transparent glass

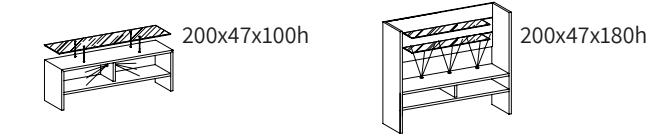

TAVOLI RIUNIONE | MEETING TABLES

Top legno | Wood top



Cuoio | Thick leather



Top vetro | Glass top



TAVOLI ATTESA | SIDE TABLES

Legno | Wood

Cuoio | Thick leather

Vetro trasparente | Transparent glass

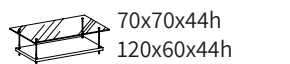
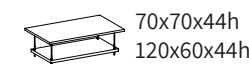

Rendered by

Andrea Macor Rendering
Alberto Codognotto | Kodocreation

Print

Treviso Stampa

Copyright© 2018
by Codutti Furniture S.r.l.



executive

GENESIS

collection

UDINE
ROME
LONDON
SHANGHAI
PANAMA
MOSCOW
MUMBAI
CHILE

